

A large black left square bracket and a large yellow right square bracket are positioned on either side of the title, framing the text. The background behind the text is a horizontal gradient bar transitioning from olive green on the left to light yellow on the right.

GAS ABSORPTION TECHNIQUES

Gas Absorption Techniques

ABSORPTION DEVICES

Absorption means the dissolution of molecules within a liquid collecting medium.

Absorption of pollutant gases is accomplished by using a selective liquid in a:

- wet scrubber,
- packed tower,
- or bubble tower.

Pollutant gases commonly controlled by absorption include sulfur dioxide, hydrogen sulfide, hydrogen chloride, chlorine, ammonia, oxides of nitrogen, and low-boiling hydrocarbons

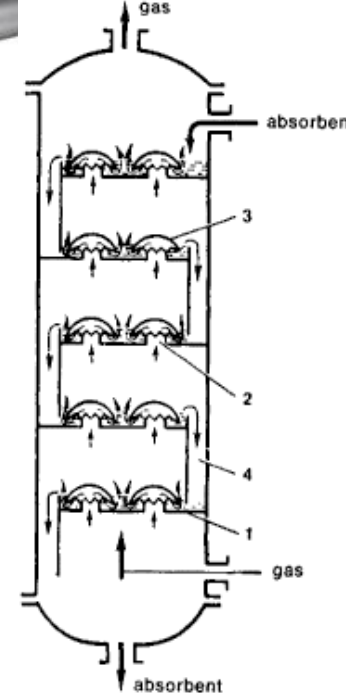
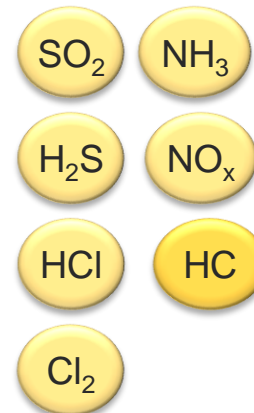
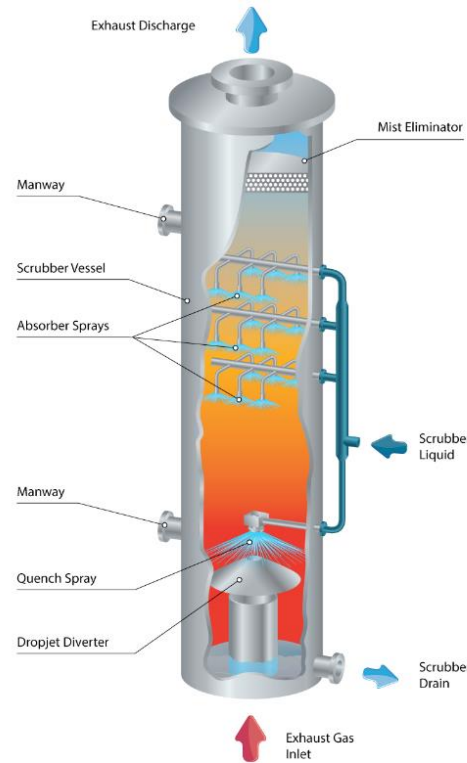

Operating principles

Key aspects:

- The scrubbing liquid must be chosen with reference to the gas being removed:
- The gas solubility in the liquid solvent should be high so that reasonable quantities of solvent are required.
- The solvent should have a low vapor pressure to reduce losses, be noncorrosive, inexpensive, nontoxic, nonflammable, chemically stable, and have a low freezing point.

Water is the most popular solvent used in absorption devices.

The water solution may be treated with an acid or a base to enhance removal of a specific gas.

Water scrubbing is very effective for the control of:



Chlorine,



hydrogen chloride



hydrogen fluoride

All of them are readily soluble in water

Water cannot be used if the targeted vapor has low aqueous solubility.



Sulfur dioxide, for example, is only slightly soluble in water, so a scrubber of very large liquid capacity would be required. SO₂ is readily soluble in an alkaline solution, so scrubbing solutions containing ammonia or amines are used in commercial applications.

Operating principles

○ Wet systems: basic principles

- **physical** (dissolution) or **chemical** absorption of the gaseous compound in a proper liquid
- process **kinetics**: **general law** for interphase mass transport phenomena

$$N = k \cdot S \cdot \Delta c$$

N = mass transfer velocity (mass/time)

k = mass transfer coefficient (turbulence, liquid type) → solvent, equipment configuration

S = gas/liquid interface surface → equipment configuration

Δc = driving force → equipment configuration, solubility and/or gas/liquid reactivity (solvent)

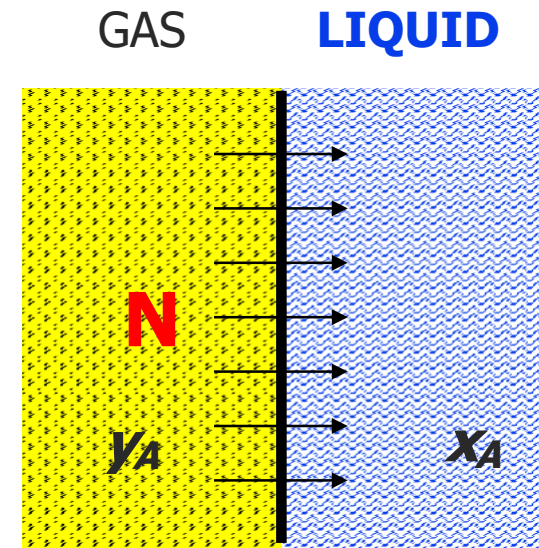

Operating principles

- **Driving force** → difference between **concentration** in **one phase** and **concentration** in the same phase **in equilibrium** with the **other phase**

$$\text{Driving force } \Delta c = y - y^* = x^* - x$$

y = gas concentration

y^* = gas concentration in equilibrium with liquid

x = liquid concentration

x^* = liquid concentration in equilibrium with gas

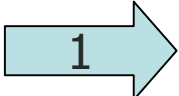

- always defined in terms of distance from equilibrium
- all systems tend to equilibrium, with **velocities** increasing with the distance from equilibrium

$y > y^*$  Gas → liquid (absorption)

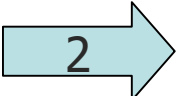
$x > x^*$  Liquid → gas (stripping)

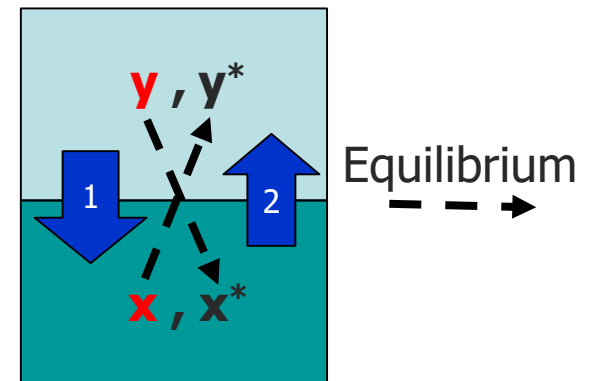

Operating principles

- Gas-liquid equilibrium → HENRY'S LAW

$$y^* = H \cdot x^*$$

y^* = gas mole fraction

x^* = liquid mole fraction

H = Henry's law constant → solubility = function of T, P

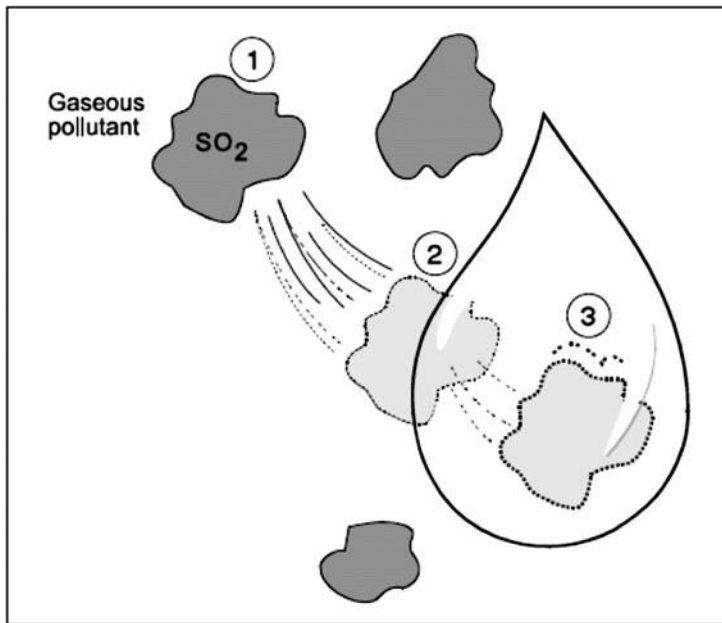

Gas Absorption

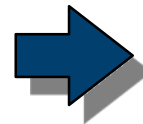

Air Pollution Control

T increase, H increase

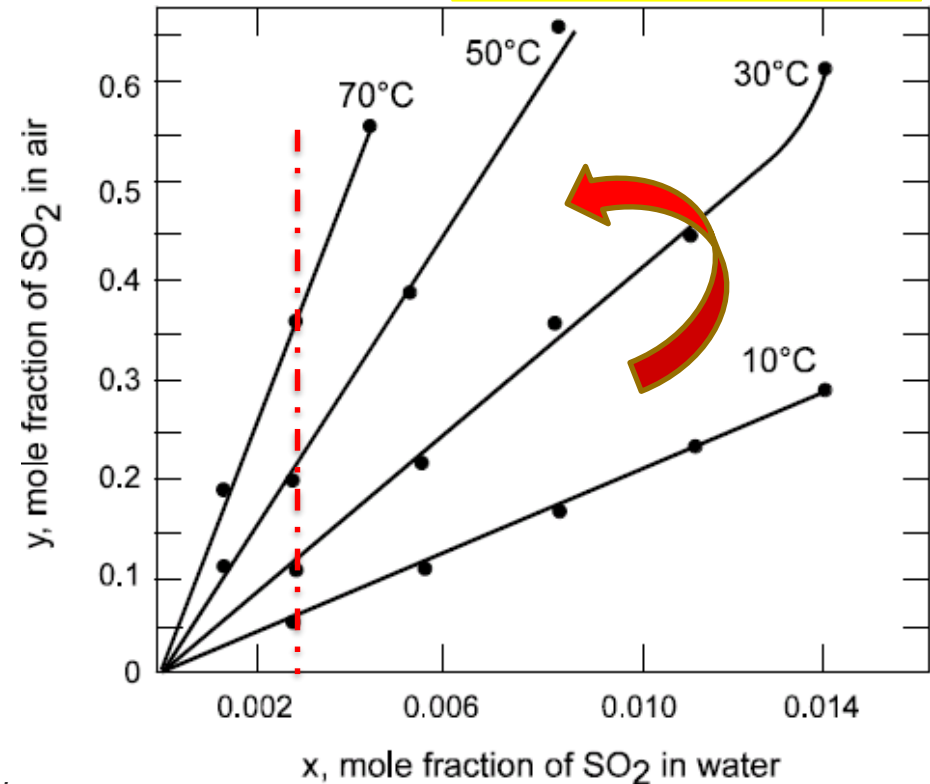

Operating principles

Driving force ΔC

$$\Delta C = y - y^* = x^* - x$$

$$\rightarrow \Delta C = y - H \cdot x = (y/H) - x$$



high ΔC for

- low $H \rightarrow$ high solubility (liquid selection)
- high average $(y - Hx)$ along absorption system \rightarrow countercurrent flow configuration
- fast interface renewal \rightarrow gas/liquid contact turbulence
- low $x \rightarrow$ high liquid flow rates (costs)

Liquid characteristics for optimal process operation

The logo for wooclap, consisting of the word "wooclap" in white lowercase letters on a blue square background.

wooclap

In your opinion which are the most important requirements for the liquid to be used in gas absorption systems?

Operating principles: Interface surface S / turbulence

- **higher S** required for **increasing mass flux N**
- **higher turbulence** required for increasing k



- system engineering configuration
 - **packed columns**: liquid dispersion in a thin layer around packing elements
 - **plate columns**: gas dispersion in bubbles across a liquid layer through appropriate plates
 - **spray chambers**: liquid dispersion in drops through nozzles



Operating principles: Liquid to gas flow rate, L/G

Liquid to gas flow rate, **L/G**, is a key parameter in wet scrubbers; *usually it is expressed as **liters** (recycled liquid) / **m³** (actual outlet gas flow)*. Higher liquid flow rates, hence higher L/G values, are indicative of higher levels of control of the pollutants. *(Below, the L/G is reported as a mass ratio)*.

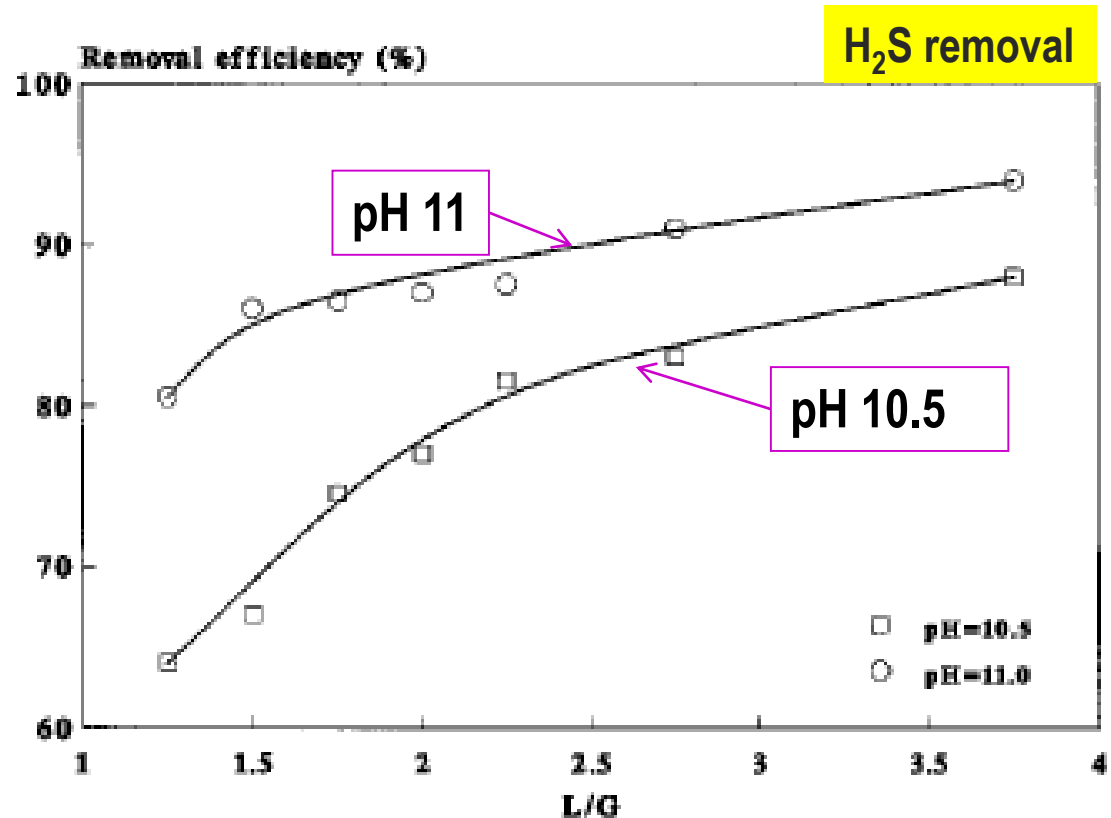

The results of two sets (Figure above) of experiments were run to determine the effect of L/G on H₂S removal in alkaline solutions, at pH 10.5 and 11.0.

The results indicate that H₂S is more effectively absorbed at higher pH and L/G ratios.

Operating principles: pH influence for H₂S removal

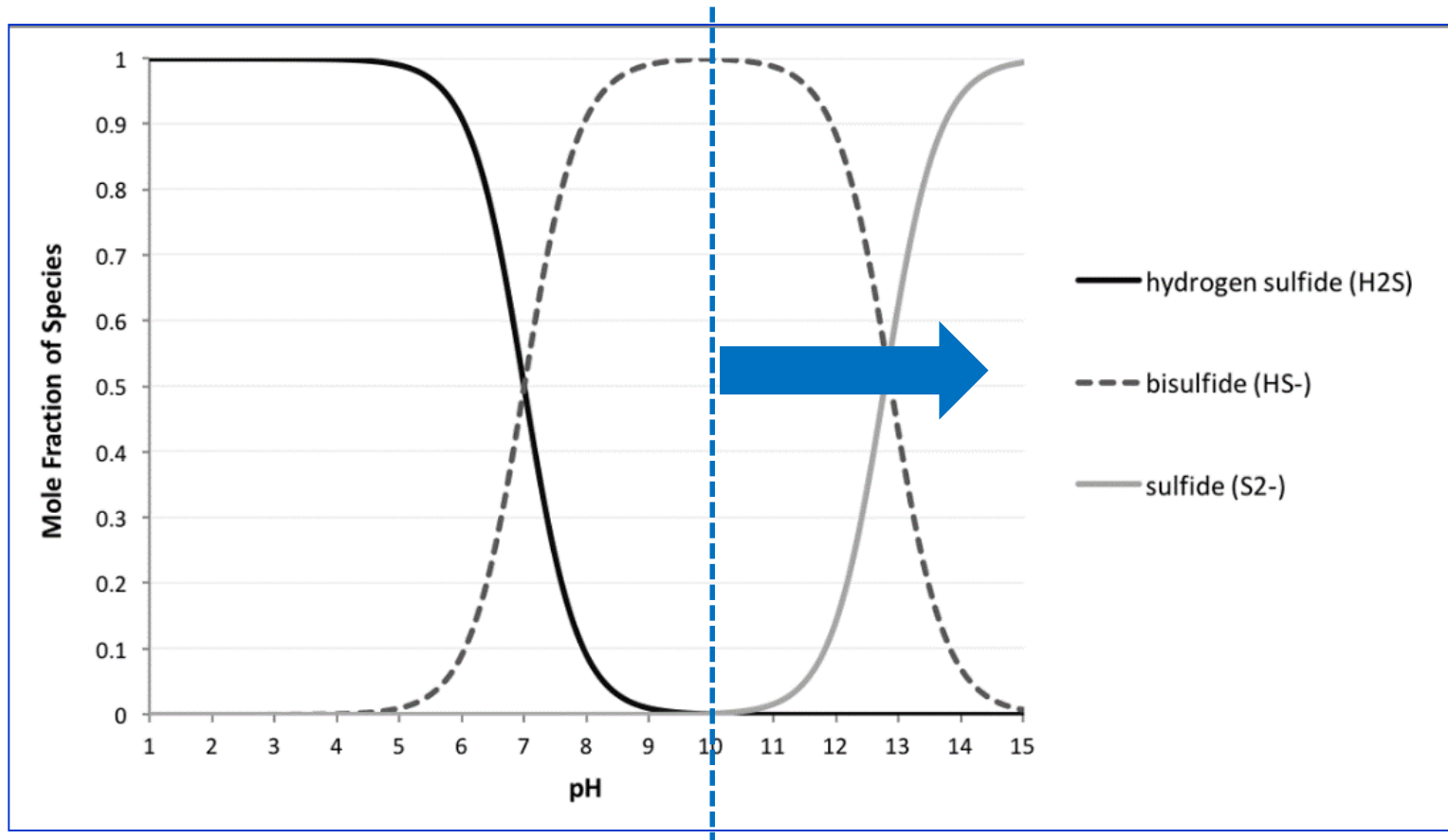

Good H₂S absorption for pH > 10 because C_{H₂S,aq} is almost zero

Operating principles: Absorption competition SO_2 / CO_2

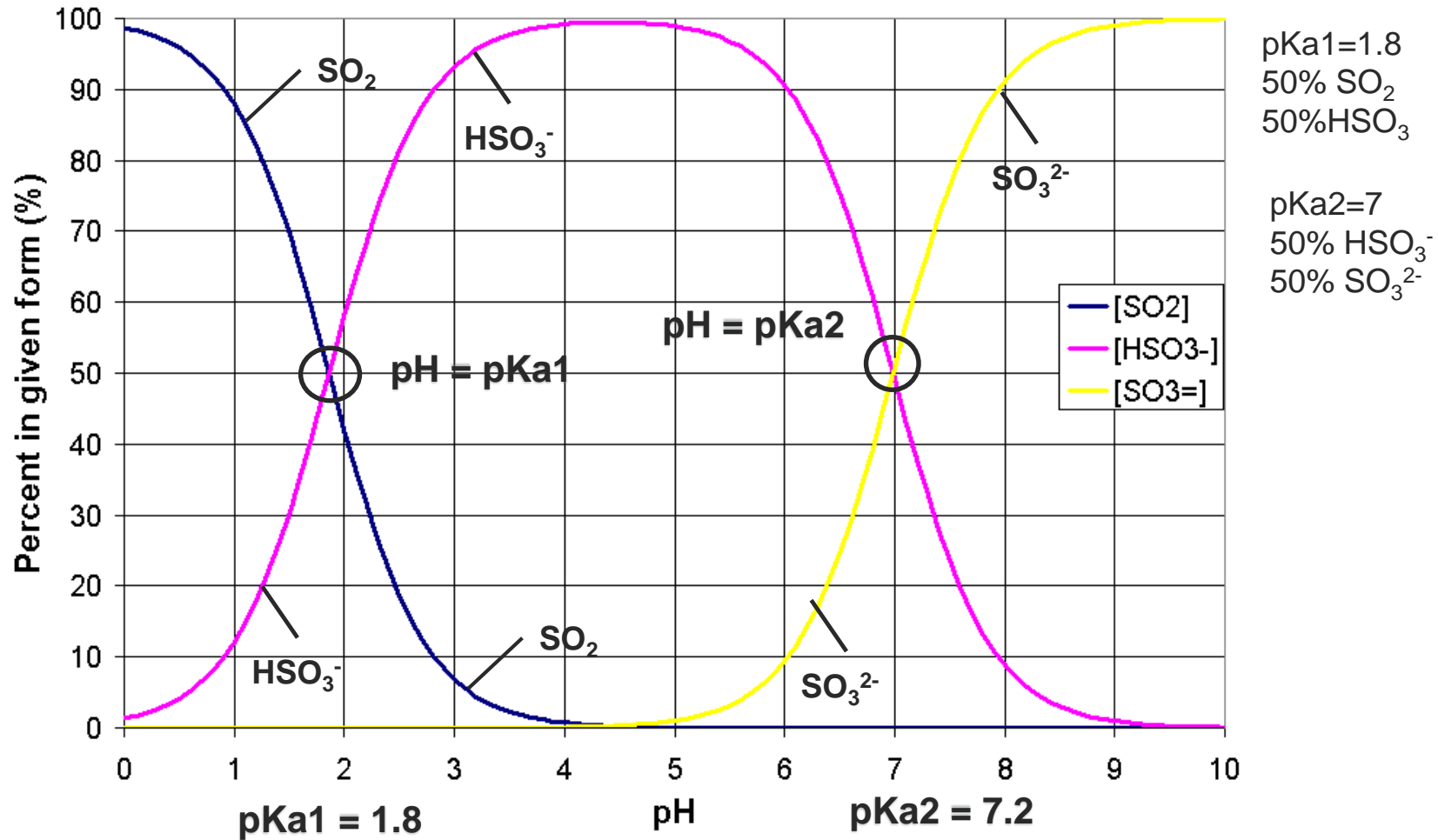

Operating principles: Absorption competition SO_2 / CO_2

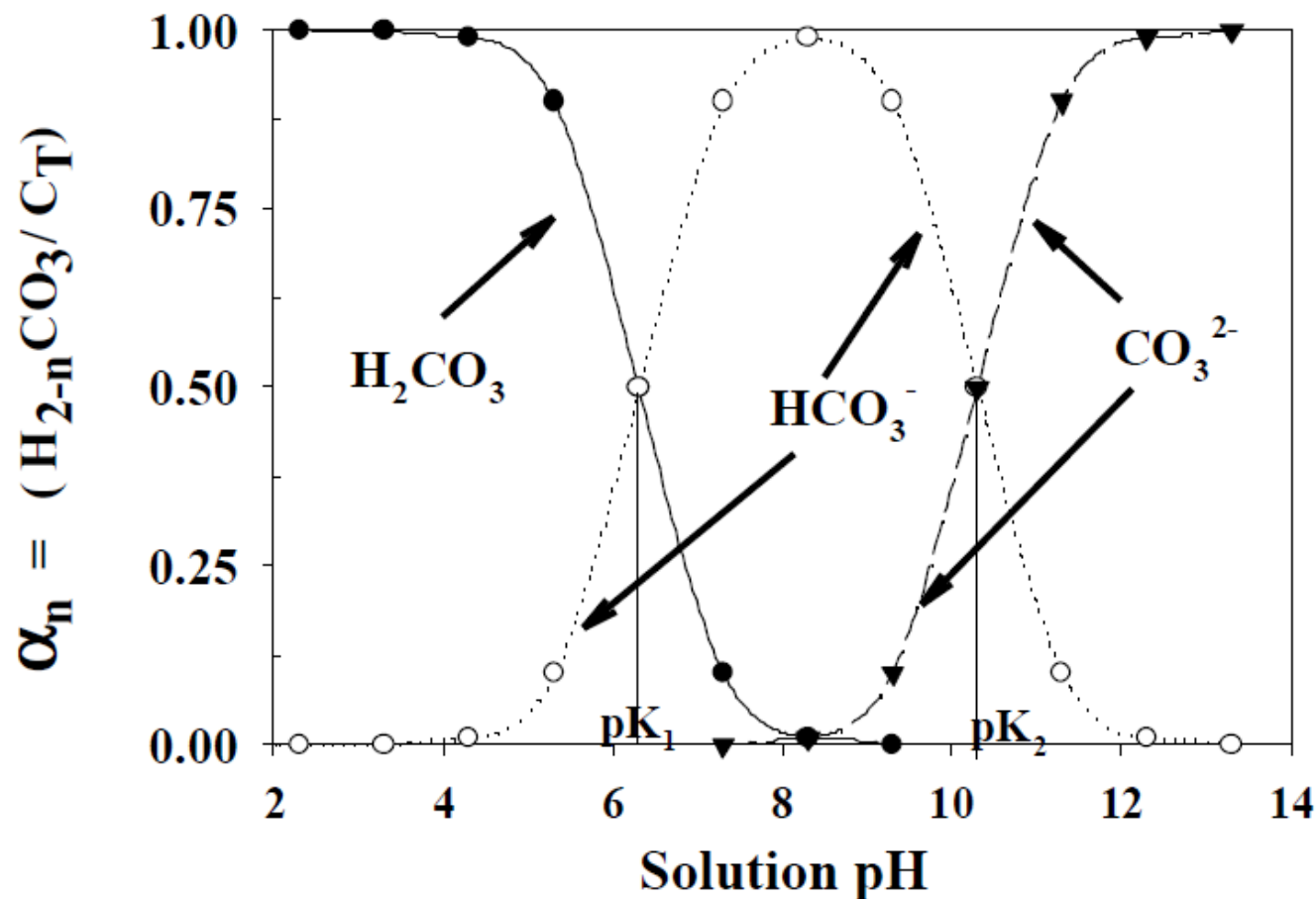

total dissolved carbonate in relation to solution pH

pKa1=6.35
50% H_2CO_3
50% HCO_3^-

pKa2=10.3
50% HCO_3^-
50% CO_3^{2-}

CO_2 doesn't have any polarity (linear molecule), therefore in water the intermolecular force is very weak, and the solubility low (as for N_2 and O_2).

Operating principles: Absorption competition SO_2 / CO_2

The logo for wooclap, consisting of the word "wooclap" in white lowercase letters on a blue square background.

wooclap

Which is the optimal range of pH for the removal of SO_2 in a Wet Scrubber?

Operating principles: summary

AIM OF ABSORPTION: maximize the mass transfer (N) from gas to liquid phase

- Turbulance
- Liquid type

- Input value

- low x: high liquid flow rates (costs)

$$N = k \cdot S \cdot (y - H \cdot x)$$

- Equipment configuration (packing elements)

- Low H, high solubility
- Low temperature for the absorption process
- High total preassure (measure not very used)
- Adding chemicals to water (alkaline solutions, acid solutions, solutions with oxidizing agents)
- Correct range of pH (competitive reactions, Heff)

System engineering configuration: plate towers

- **intermittent** gas/liquid contact over **trays** with **liquid dispersion openings** (bubble caps, holes, valves) for **increasing gas/liquid interface and turbulence** (froth) → **efficiency**
- application for **particulate laden gases**
- good control for **chemical absorption**

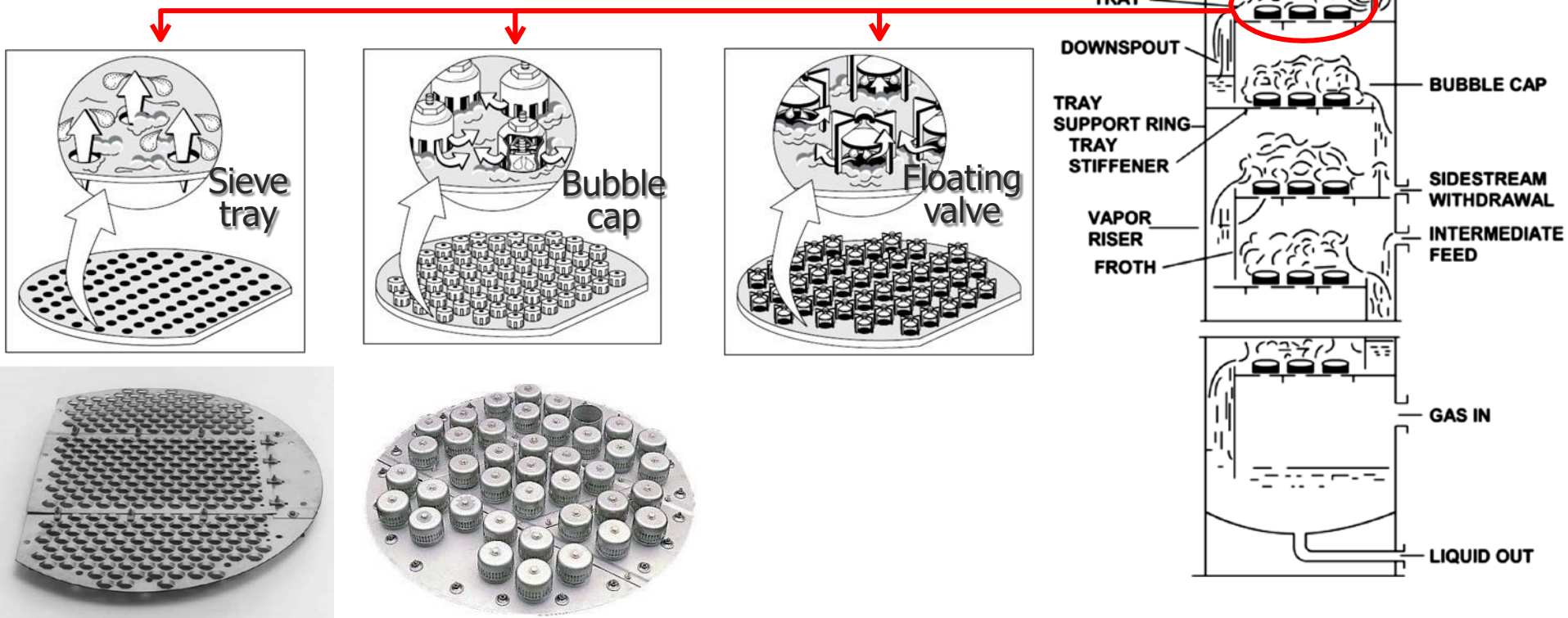

System engineering configuration: venturi scrubber

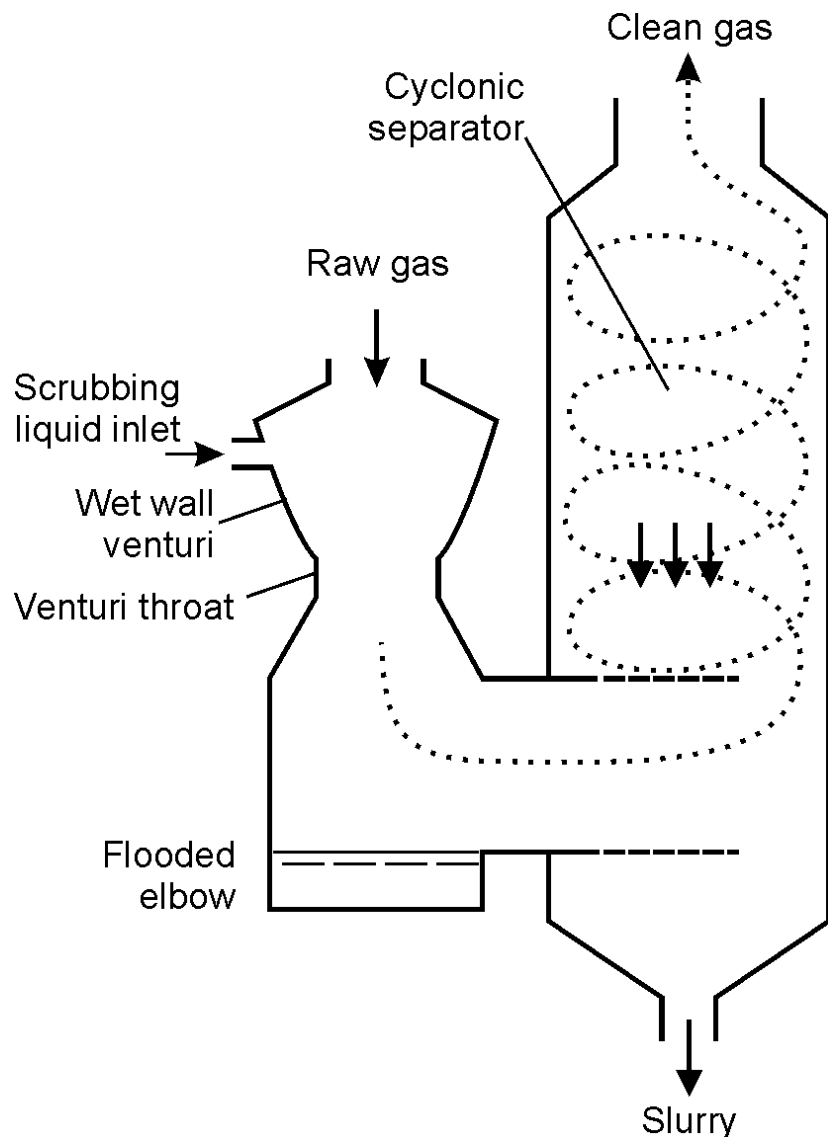

Designed for the acid gases removal, but have a good removal efficiency also for dust.

In principle a venturi scrubber is a throat in a gas tube, so that from the converging part the gas is strongly accelerated

Water is sprayed into the gas or into the throat, and since the velocity of water droplets is lower than that of the gas the particles in the gas collide with the droplets and are thus separated from the gas.

For <math><2.5\text{ mm}</math> particles the removal efficiency can be equal to 90%

System engineering configuration: packed columns

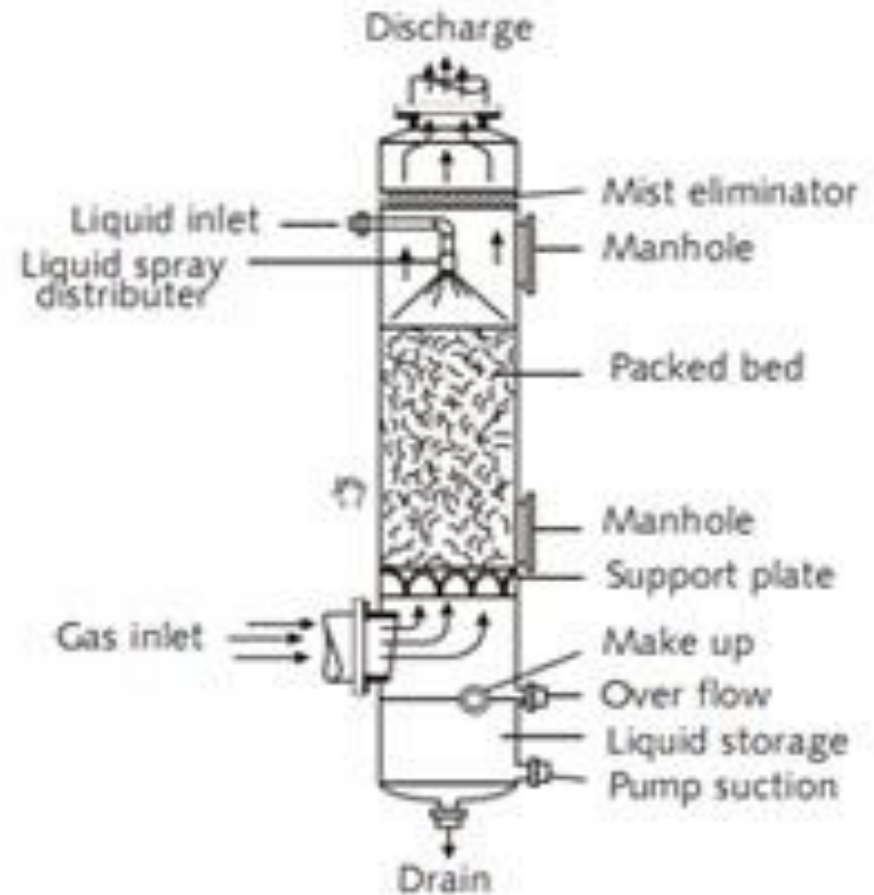
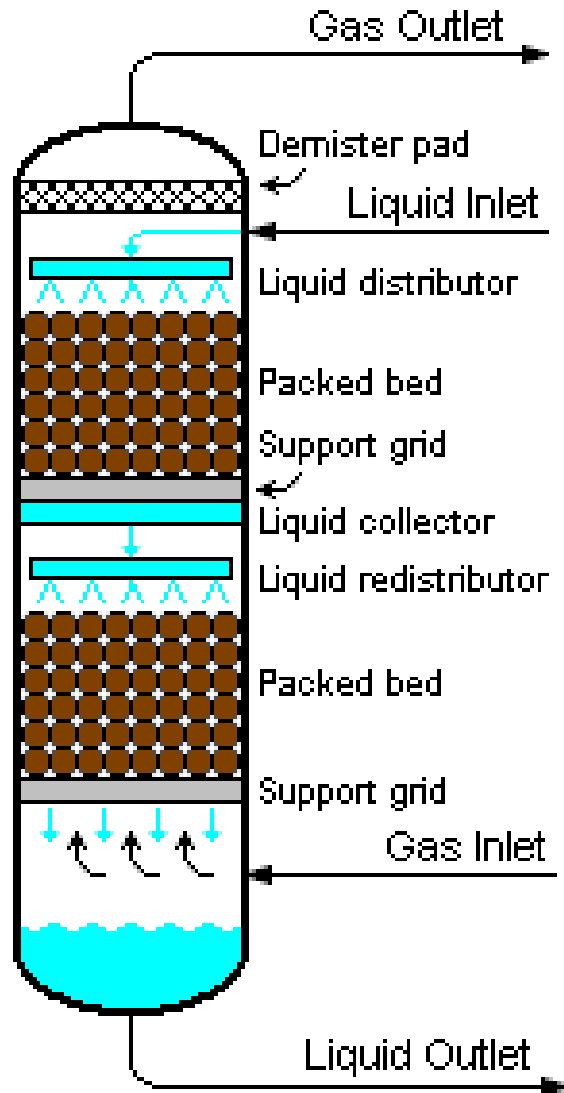

WS configurations

1. co-current flow
2. counter-current flow
3. cross-current flow

SPRAY-SCRUBBERS

Co-current Flow

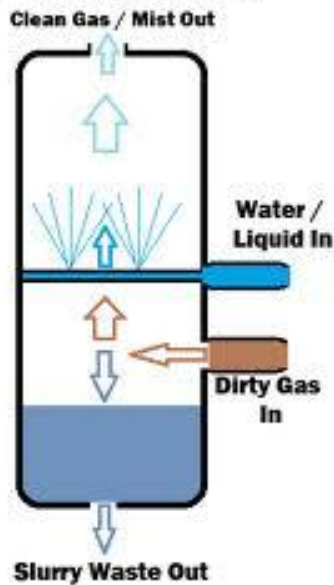

Gas Absorption

Counter Current Flow

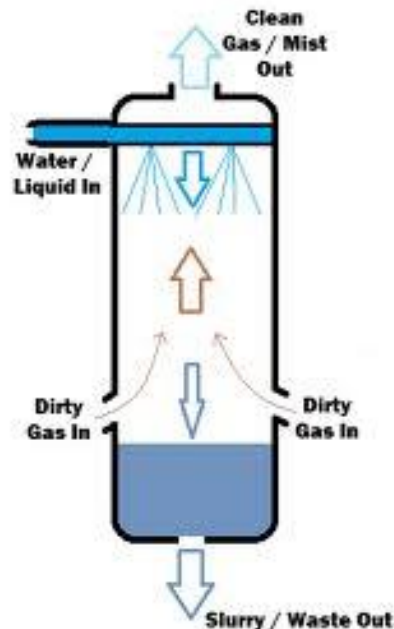

Air Pollution Control

Cross Current Flow

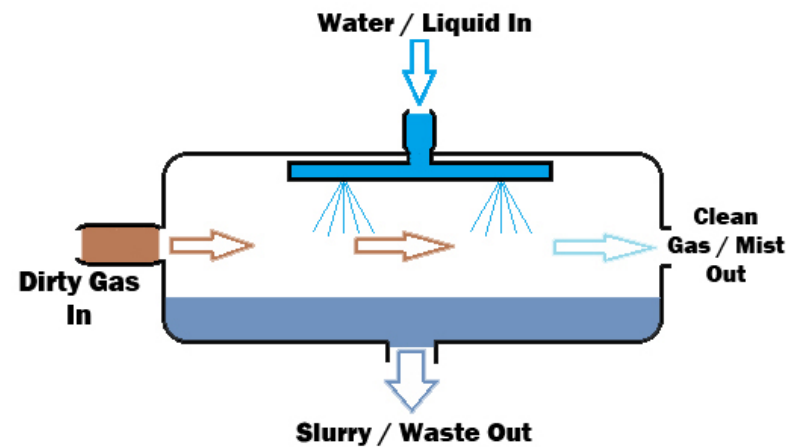

Wet scrubbing

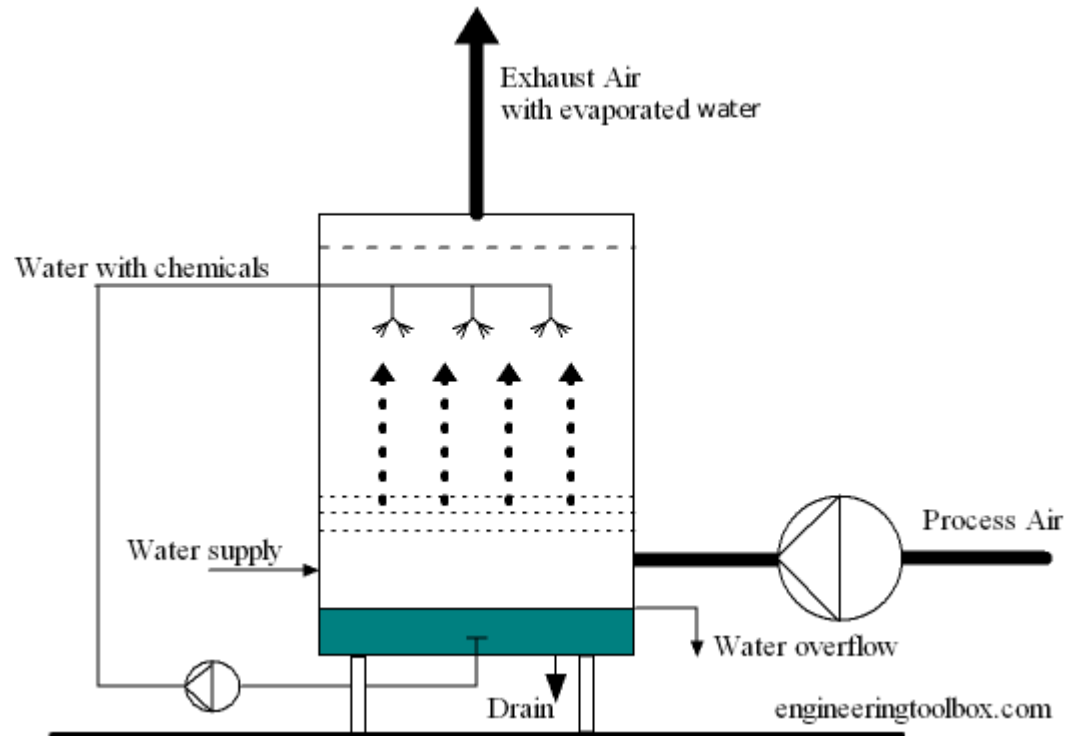
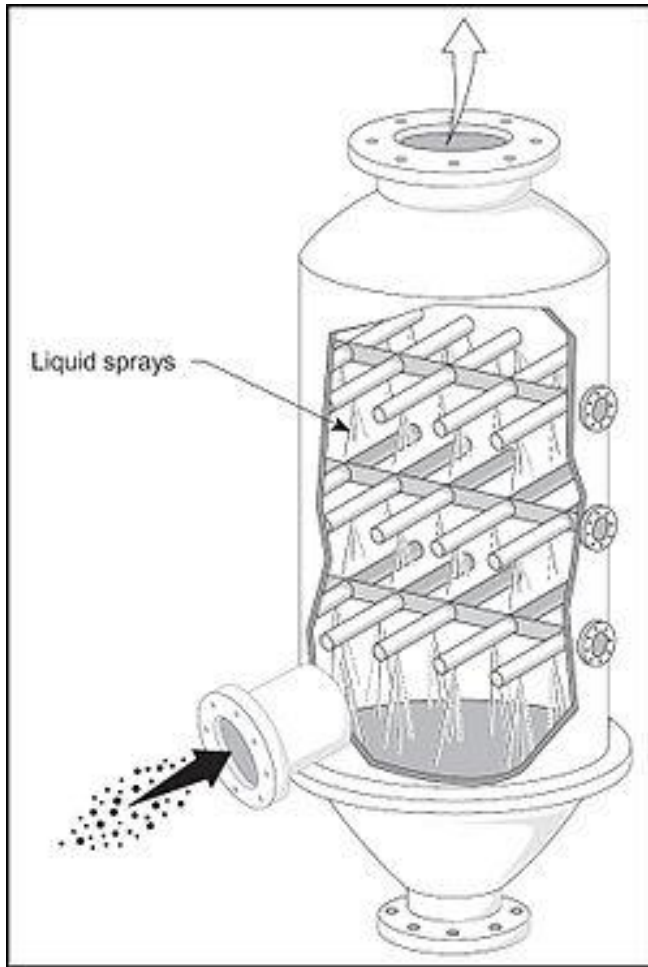

Wet scrubbing



Gas Absorption



Air Pollution Control

DESIGN CONFIGURATION FOR PACKED BED TOWER GENERAL CONSIDERATION

PACKED WET SCRUBBERS

Packed-bed scrubbers consist of a chamber containing layers of variously-shaped packing material, such as Raschig rings, spiral rings, or Berl saddles, that provide a large surface area for liquid-gas contact. The packing is held in place by wire mesh retainers and supported by a plate near the bottom of the scrubber. Scrubbing liquid is evenly introduced above the packing and flows down through the bed. The liquid “coats” the packing and establishes a thin film. The pollutant to be absorbed must be soluble in the fluid. In vertical designs (packed towers), the gas stream flows up the chamber (countercurrent to the liquid).

WET SCRUBBING depends on properties of the gas stream and liquid solvent, such as density and viscosity, as well as specific characteristics of the pollutant(s) in the gas and the liquid stream (e.g., diffusivity, equilibrium solubility). These properties are temperature dependent.

Lower temperatures favor absorption of gases by the solvent under equilibrium conditions!

THE SCRUBBING PROCESS, however, LASTS ALWAYS NO MORE THAN FEW SECONDS: gas diffusion in the liquid and chemical kinetics are faster at higher temperatures.

Scrubbing is a dynamic process: two opposite trends occur by changing the temperature, which partially compensate. The effective result is pollutant specific, and cannot easily be predicted. A moderate increase of temperature (e.g. from 20 to 70°C) in the wet scrubber does not change much the scrubbing efficiency, and a possible yield increase is not a surprise! BE CAREFUL: DO NOT CONFUSE EQUILIBRIUM ABSORPTION WITH WET SCRUBBING, AS DO ALMOST ALL BOOKS AND PAPERS IN THE LITERATURE!

Absorption is also enhanced by greater contacting surface, higher liquid-gas ratios, and higher concentrations in the gas stream. Chemical absorption may be limited by the rate of reaction, **although the rate-limiting step is typically the physical absorption rate, not the chemical reaction rate.**

PACKED WET SCRUBBERS: Absorption of Gases soluble in water

Water is the most common solvent used to remove inorganic contaminants. Only organic pollutants soluble in water, or which become soluble as a result of reaction with a suitable added reagent, can be wet scrubbed by aqueous solutions.

Pollutant removal may be enhanced by manipulating the chemistry – *Thermodynamics and Kinetics* - of the absorbing solution so that it reacts with the pollutant. **Chemicals are added to increase K_H and the reaction velocity.**

Alkaline solution

Caustic solution (**sodium hydroxide, NaOH**) is the most common scrubbing liquid used for acid-gas control (e.g., HCl, SO₂, or both), though calcium hydroxide (**slaked lime, Ca[OH]₂**) is also used, but only with suitable scrubbers (probable CaCO₃ sludge production). When the acid gases are absorbed into the scrubbing solution, they react with alkaline compounds to produce neutral salts. Increased rate of gases absorption occur with higher solubility of the gases in the scrubbing liquid, higher gradient concentration at the gas-liquid interface, higher reaction rates, higher equilibrium constants.

Sodium hydroxide is completely soluble in water, while calcium hydroxide not, in fact it is used in slurry.

Acid solution

Hydrochloric acid (HCl), sulfuric acid (H₂SO₄) and nitric acid (HNO₃) can be used for alkaline gaseous compounds (es. ammine, ammonia); hydrochloric acid represents the best solution.

The products from HCl are more soluble than the ones from sulfuric and nitric acids. For example CaSO₄ (Calcium sulfate) is not high soluble in water, with problems of scale formation.

Being a powerful oxidizing agent, nitric acid reacts violently with many non-metallic compounds and the reactions may be explosive

Solution with oxidizing agents

Another approach is to use oxidizing agents as sodium hypochlorite (NaOCl) and hydrogen peroxide (H₂O₂).

PACKED WET SCRUBBERS

The logo for wooclap, consisting of the word "wooclap" in white lowercase letters on a blue square background.

wooclap

In your opinion which are the most important requirements that a packing system should have?

PACKED WET SCRUBBERS

- **high surface** for gas-liquid contact (**packing elements**)
→ **efficiency**
- gas loaded with particulate → **risk of clogging**
- pressure drops

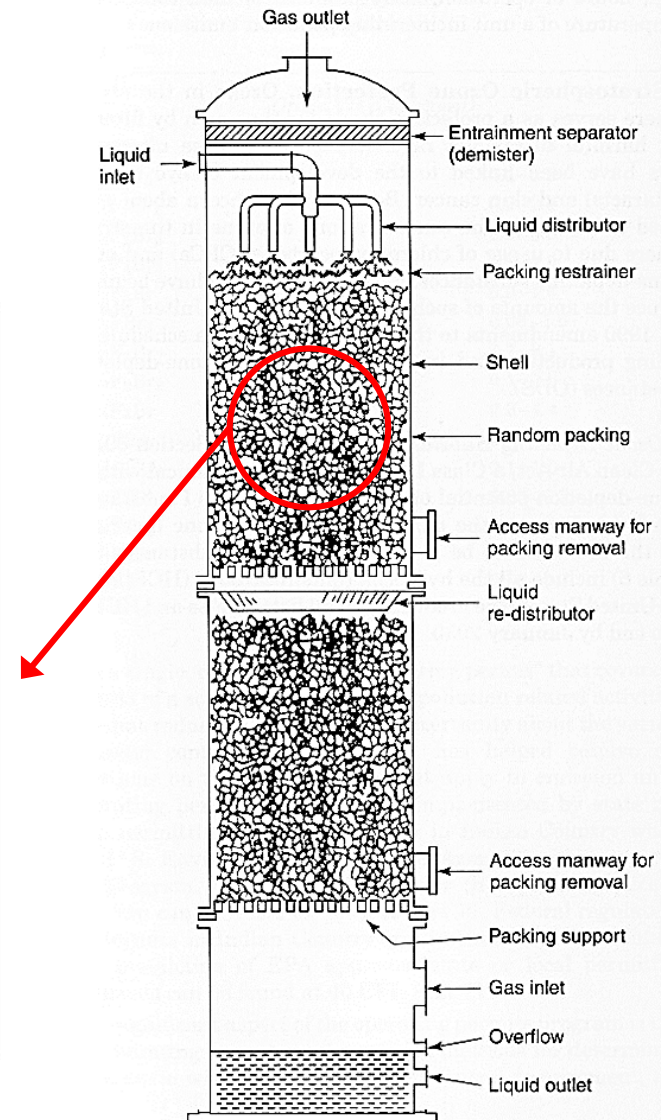
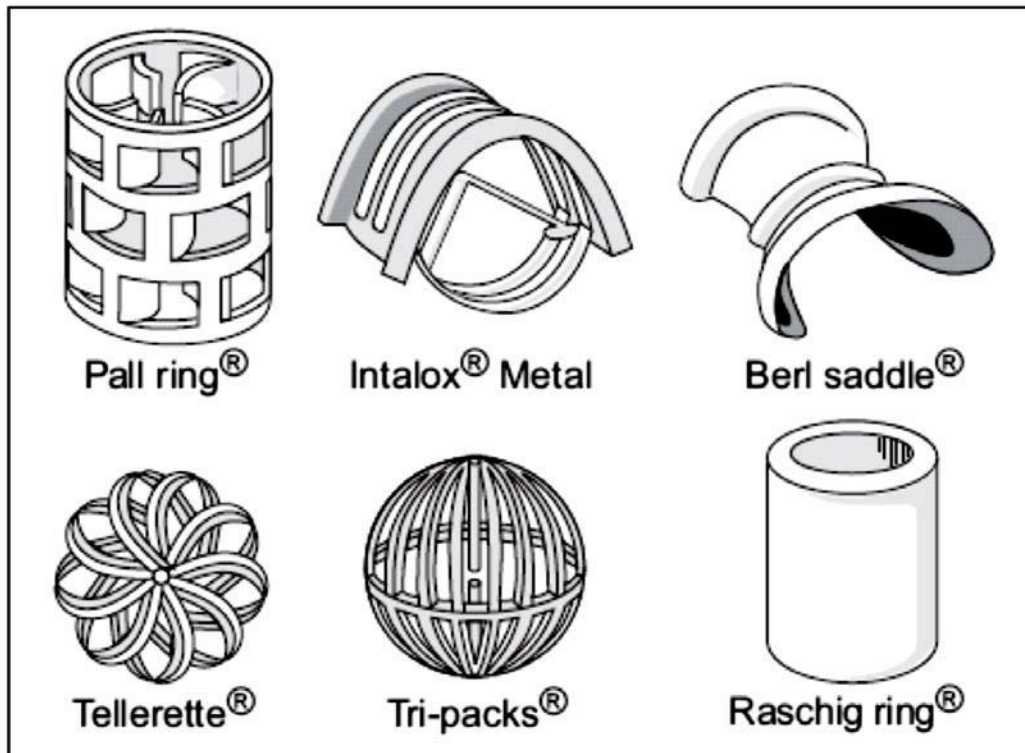

Packing in Wet Scrubbers

Packing elements inside the WS increase the surface area, that is the gas-liquid interphase area; the specific surface area of the packing material is measured as m^2/m^3 . Two types of packing are available: **random packing and structured packing.**

Random packing is a classical and most used packing

Structured packing provides a lower pressure drop per theoretical stage and increased capacity compared to trays and conventional random packings.

Packing surface ranges from **50 m^2/m^3** (lowest efficiency, highest capacity) **to > 1000 m^2/m^3** (highest efficiency, lowest capacity).

Air Velocity – packed wet scrubbers

The air velocity through wet scrubbers is recommended to be less than 4.0 m/s.

Packing in Wet Scrubbers

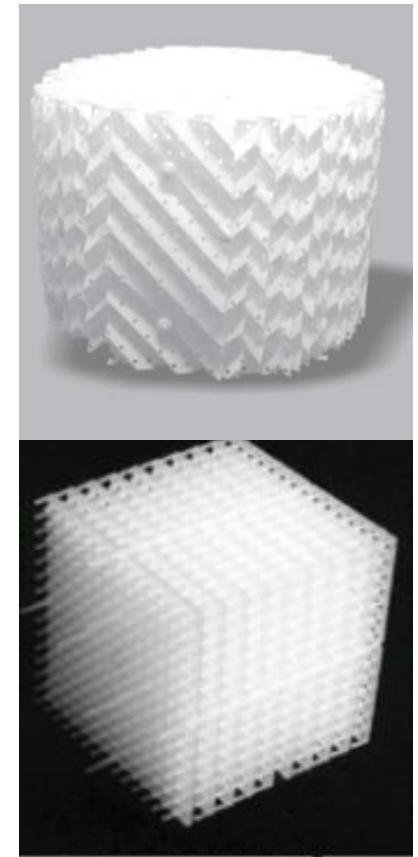
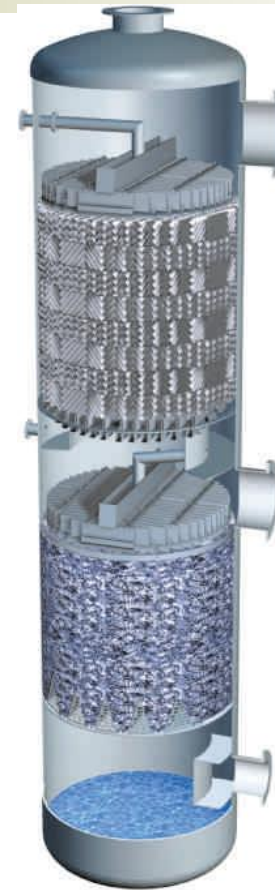
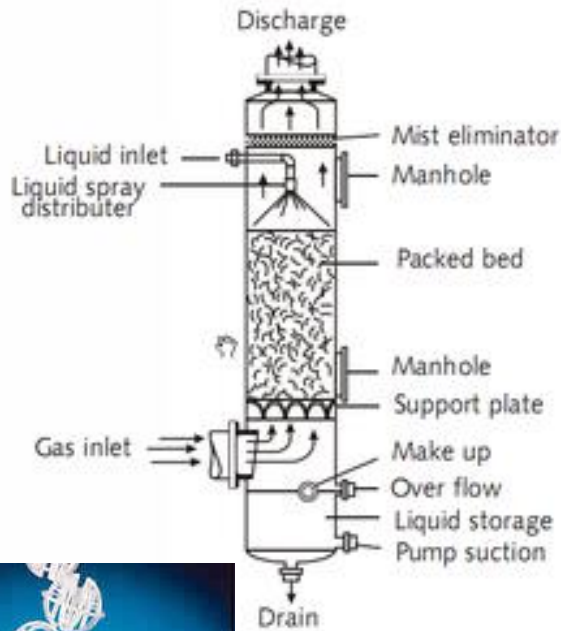
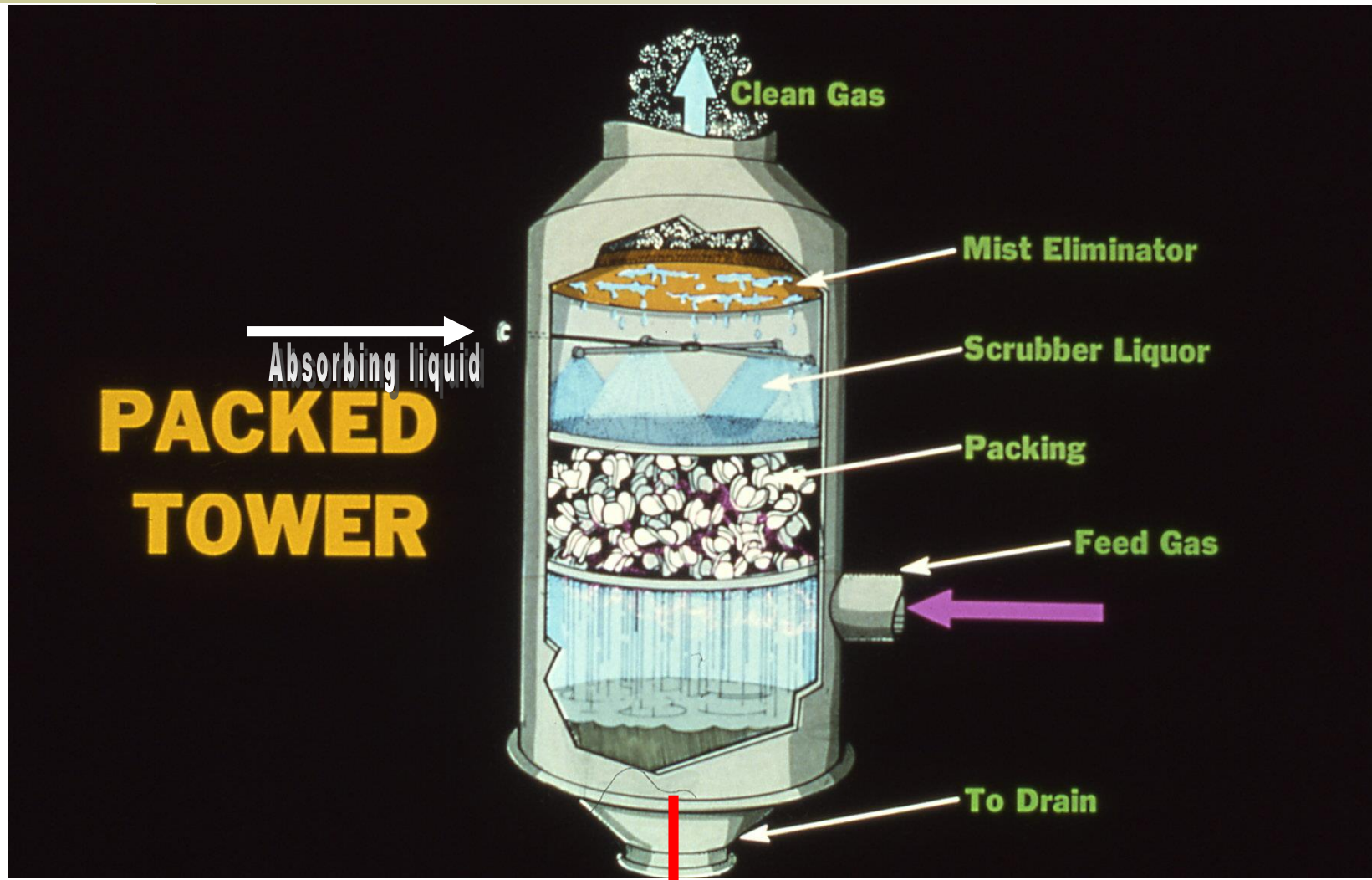

Figure 3. HD Q-PAC[®]

Random packed tower
(both metallic and plastic (PTFE, PP, ...) packings are available)

Structured packed tower
(both metallic and plastic (PTFE, PP, ...) packings are available)



Liquid discharged
(bleed or blowdown)

Packing materials



Packing materials to increase gas-liquid interface in packed scrubbers.

Materials: ceramics, plastics, metals. Plastics (PP, PVDC, ..) are inert and lighter: better!

CASE STUDY - Packing materials used in a packed scrubber in the gas-liquid interface

	Q-PAC® (COLUMN PACKING)	#2 NUPAC® (DEMISTER)
Nominal Size	8.25 cm x 9.5 cm	6.5 cm
Void Fraction	96.3%	90.9%
Geometric Surface Area	98.4 m ² /m ³	55 m ² /m ³
Weight - polypropylene	33.7 kg/m ³	81 kg/m ³
Number of Pieces	1165/m ³	4400 /m ³
Weight – PVDF (-CH ₂ -CF ₂ -)	65.8 kg/m ³	144 kg/m ³



Q-PAC



NUPAC 2

DEMISTERS: *droplets separators/eliminators*

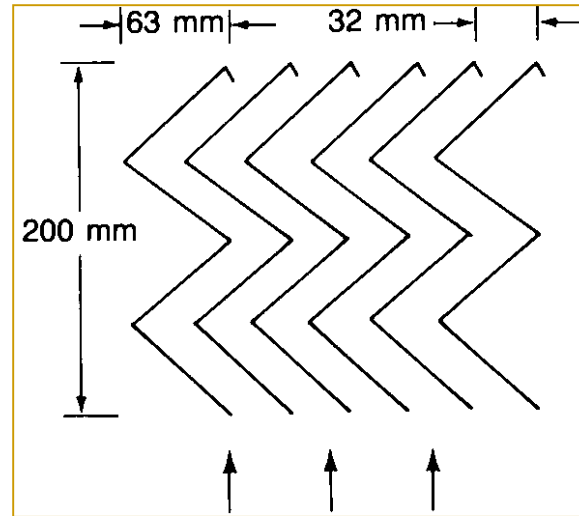
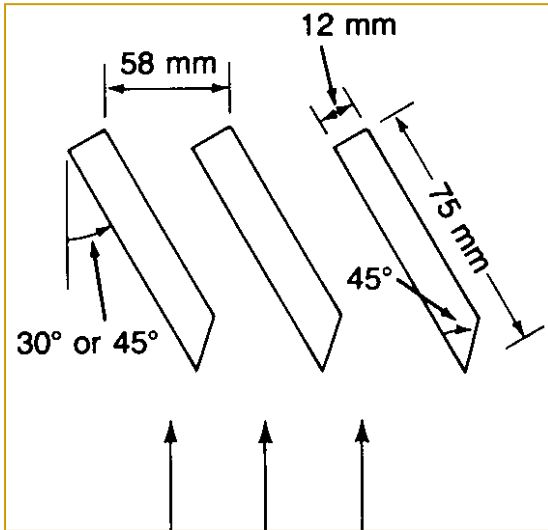

Chevron mist eliminators

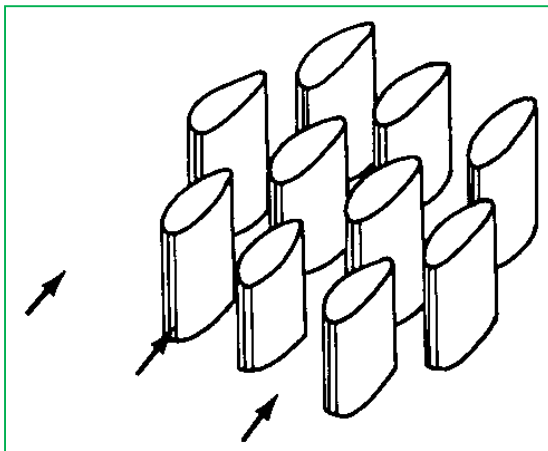

Gas Absorption

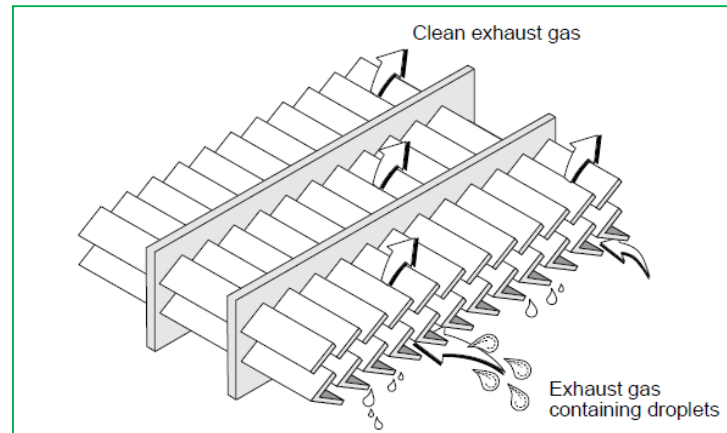

Air Pollution Control

DEMISTERS: *droplets separators/eliminators*

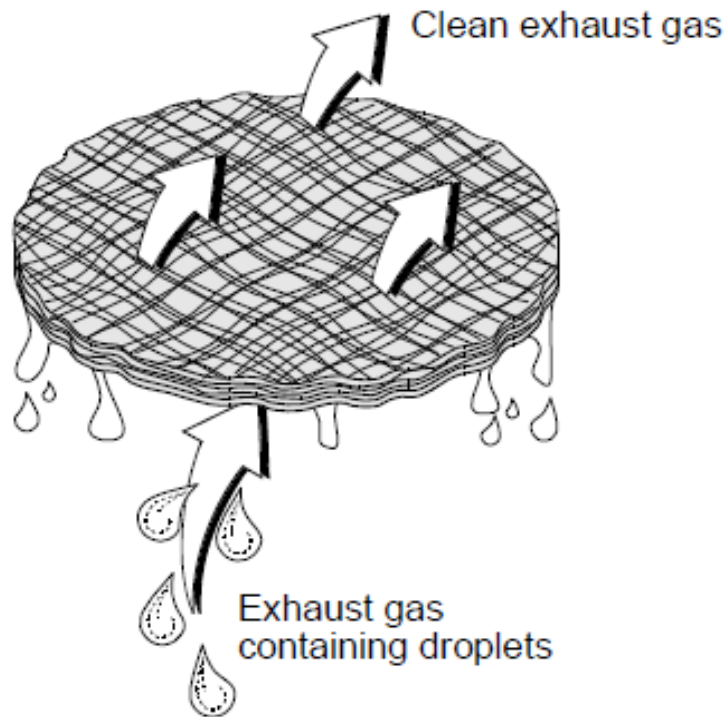

Mesh pads are formed from woven or randomly interlaced metal or plastic fibers that serve as impaction targets.

Mesh pads can be up to 15 cm thick.

As with the chevrons, there is a maximum gas velocity above which re-entrainment is possible. This maximum gas velocity, which depends on the density of the mesh, on the materials of construction, and on the gas density, is usually < 4 m/s.

Mesh-pad mist eliminator

DEMISTERS: *droplets separators/eliminators*

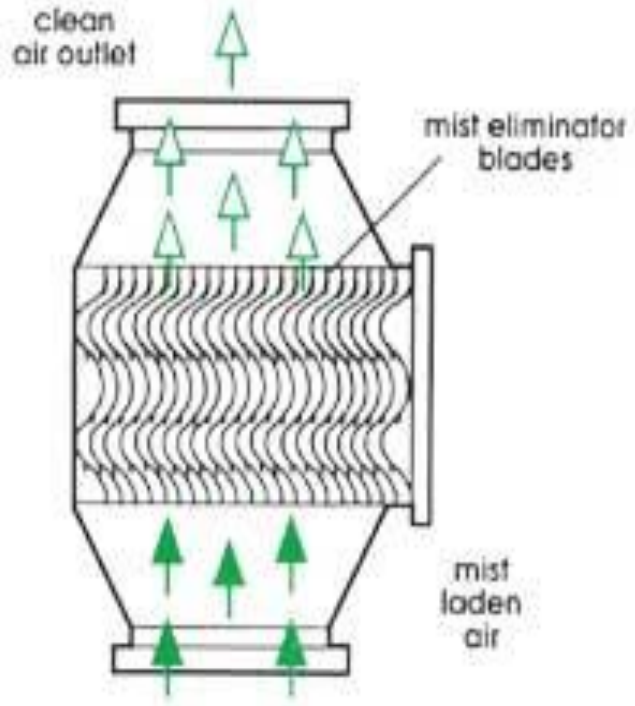
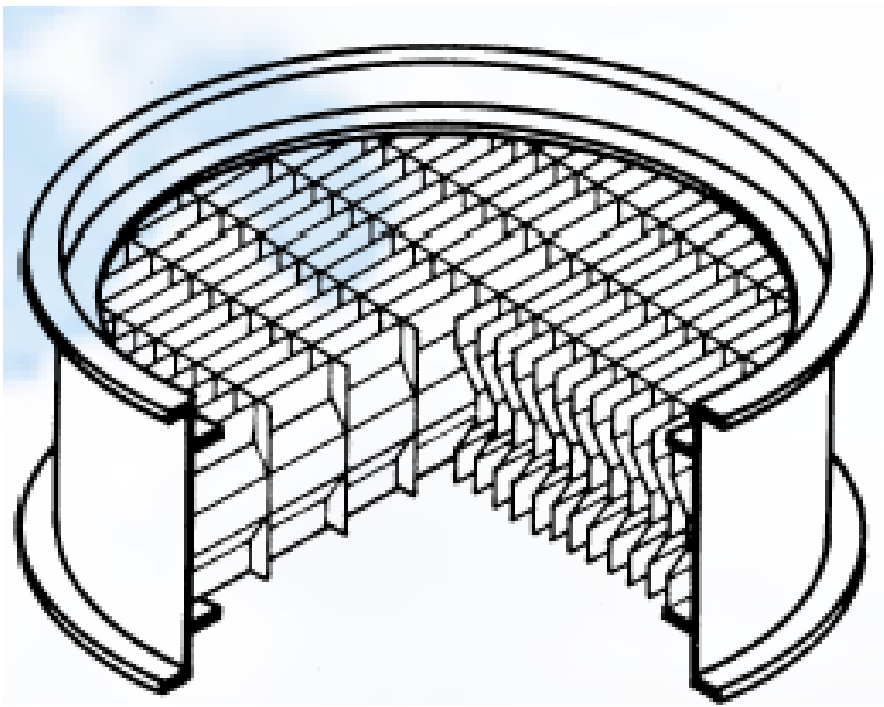

Droplets removal mechanism

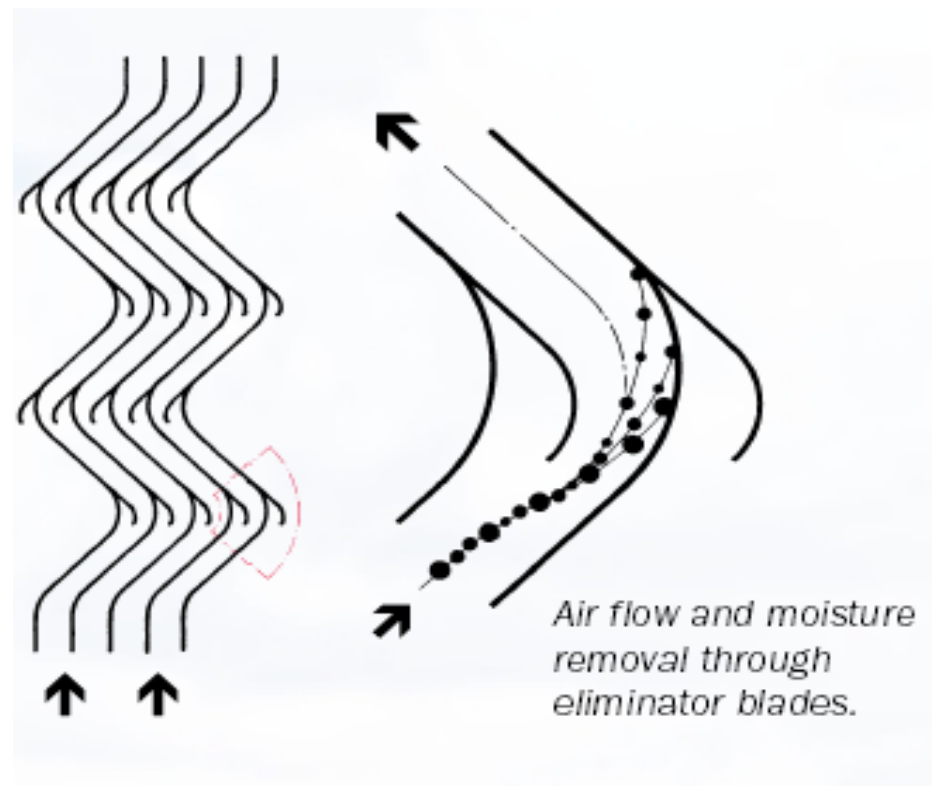

Droplet (mist) removal mechanisms (zigzag path)

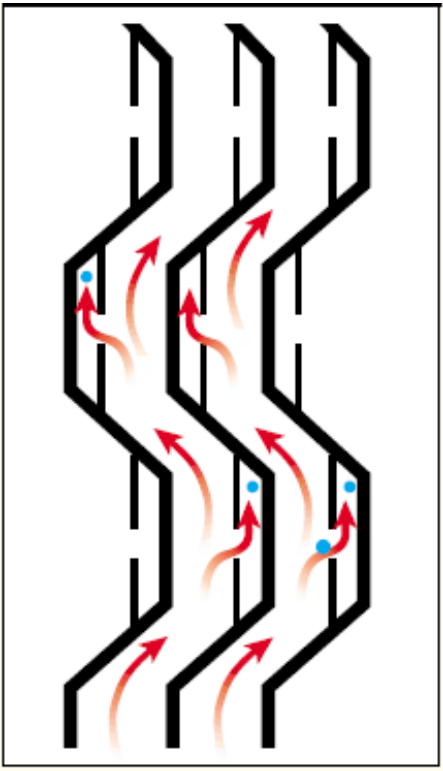

Direct Interception

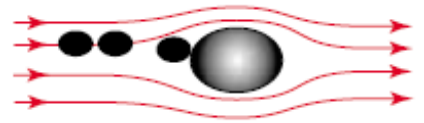

Inertial Impaction

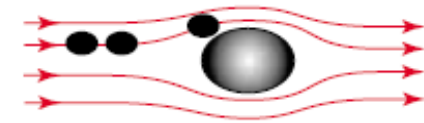

Counter-current wet scrubber

FRESH WATER MAKE-UP - Fresh water must be continuously supplied to scrubber to maintain overflow of contaminated sump water.

- ❑ **Overflow (blow-down) rate** should be maintained at 1% - 5% of scrubber recirculation rate.
- ❑ **The fresh water make-up rate** must be adequate to maintain the concentration gradient between the liquid and gas phase.

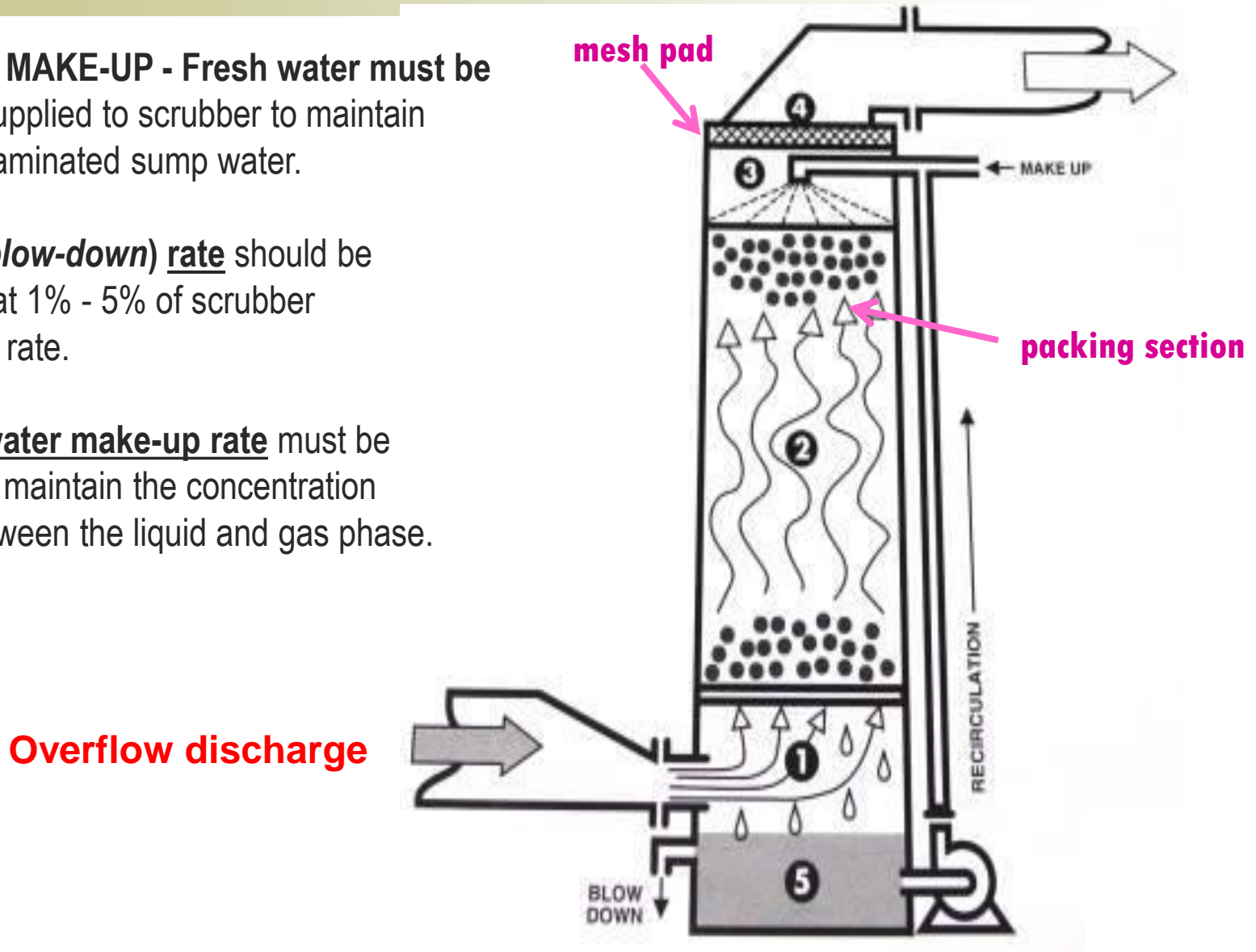

Classification of Wet-Scrubbers by pressure drop

	Pressure drop	Example
Low-medium energy scrubbers	< 1.5 kPa < 15.2 cm H ₂ O	Spray towers
Medium to high energy scrubbers	1.5 to 4 kPa 15.2 to 40.7 cm H ₂ O	Packed towers
High energy scrubbers	> 4 kPa > 40.7 cm H ₂ O	Venturi towers

- Most scrubbers, however, operate over a wide range of pressure drops, depending on their specific application, thereby making this type of categorization difficult.
- Another way to classify wet scrubbers is by their use to primarily collect either **particles** or **gaseous pollutants**. Again, this distinction is not always clear since scrubbers can often be used to remove both types of pollutants.

PRESSURE DROP: effect of gas velocity and packing

Pressure Drop Comparison

Superficial Gas Velocity (m/s)

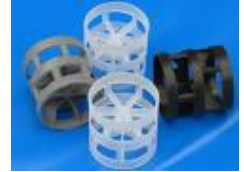
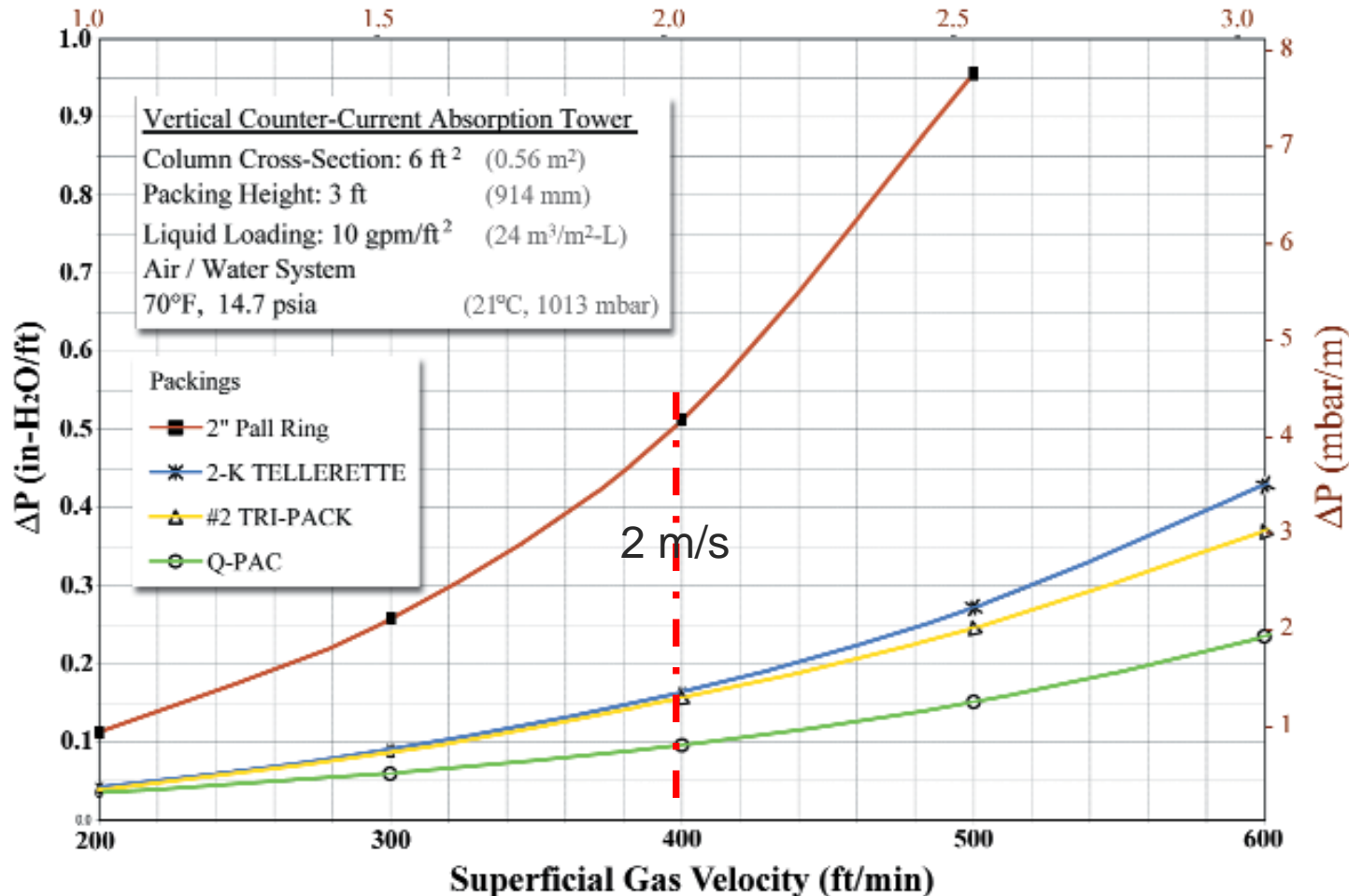

Pall Ring



2-K TELLERETTE



TRI-PACK

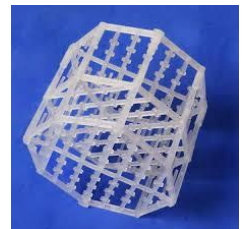

Q-PAC

WATER BALANCE

Water IN = Water OUT

Water make-up = Water consumption

Water consumption = water blow-down + water evaporated

(*) To calculate the evaporated water, the following data are necessary:

1. RH % of the Inlet gas
2. the saturation vapor pressure at the gas exit temperature.

Exercise: Material BALANCE for Process Operations

A wet scrubber is used to remove the fine material or dust from the inlet gas stream with a spray of liquid (typically water) so that outlet gas stream meets the required process or emission standards. How much water must be continually added to wet scrubber shown in Figure below in order to keep the unit running? Each of the streams is identified by a number located in a diamond symbol. Stream 1 is the recirculation liquid flow stream back to the scrubber and it is $4.54 \text{ m}^3/\text{h}$. The liquid being withdraw for treatment and disposal (stream 4) is $0.454 \text{ m}^3/\text{h}$.

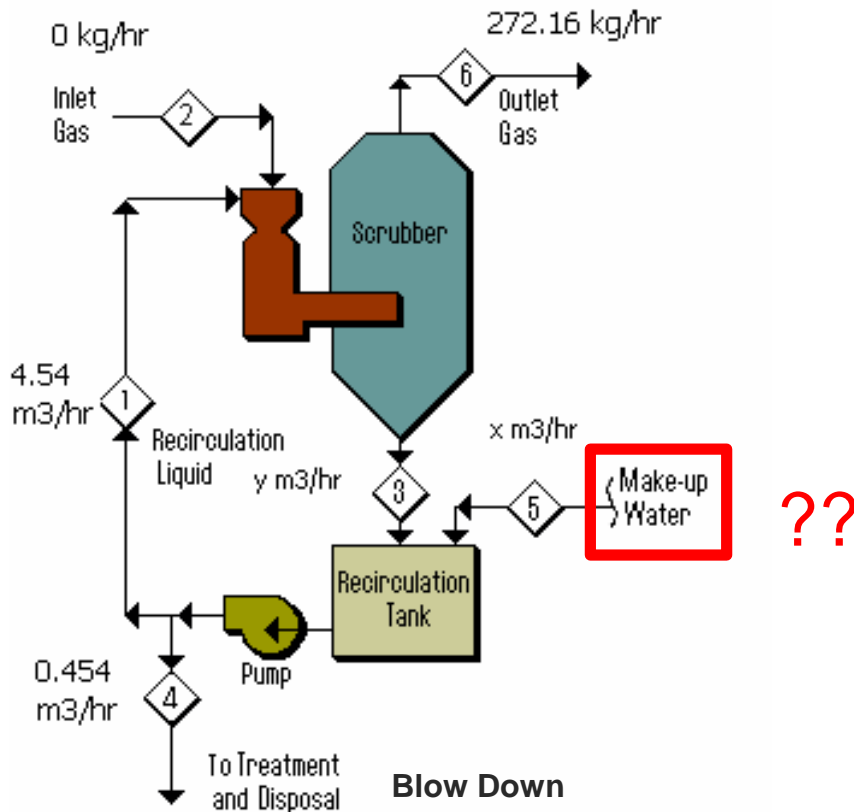

Note: *Blow down (4) / Recirculation liquid (1) = B/L = $0.454/4.54 = 0.1$*

The ratio is 10%, usually is much lower! (1%-5%)

Solution: Material BALANCE for Process Operations

A wet scrubber is used to remove the fine material or dust from the inlet gas stream with a spray of liquid (typically water) so that outlet gas stream meets the required process or emission standards. How much water must be continually added to wet scrubber shown in Figure below in order to keep the unit running? Each of the streams is identified by a number located in a diamond symbol. Stream 1 is the recirculation liquid flow stream back to the scrubber and it is $4.54 \text{ m}^3/\text{h}$. The liquid being withdraw for treatment and disposal (stream 4) is $0.454 \text{ m}^3/\text{h}$.

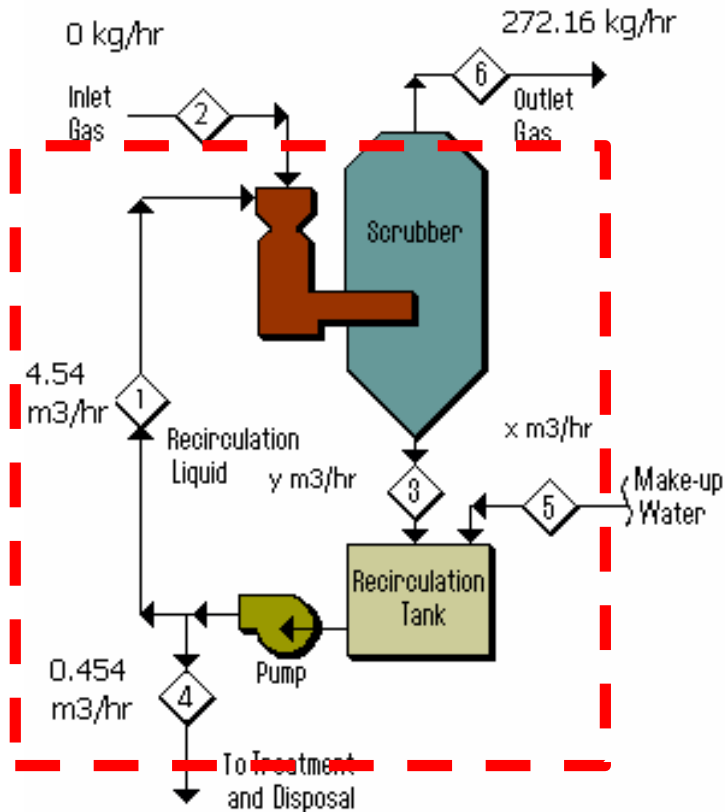

Resolution

Assume that inlet gas stream (number 2) is completely dry and the outlet stream (number 6) has 272.16 kg/hr of moisture evaporated in the scrubber. The water being added to the scrubber is the stream number 5. Mass balance IN=OUT
 $\text{stream 5} + \text{stream 2} = \text{stream 4} + \text{stream 6}$

Solution:

Step 1. Conduct a material balance around the scrubber. For Stream 6, convert from kg/h to m^3/h to keep units consistent. The conversion factor below applies only to pure water.

- Stream 6 = $272.16 \text{ kg/h} \times \text{m}^3/1000 \text{ kg} = 0.272 \text{ m}^3/\text{h}$
- If it is to calculate only the makeup water at 5,
 • Stream 5 = Stream 4 + Stream 6 = $0.454 + 0.272 = \mathbf{0.73 \text{ m}^3/\text{h}}$;
- Stream 3 = $4.54 \text{ m}^3/\text{h} - 0.27 \text{ m}^3/\text{h} = 4.27 \text{ m}^3/\text{h}$

Wet Scrubbers in series

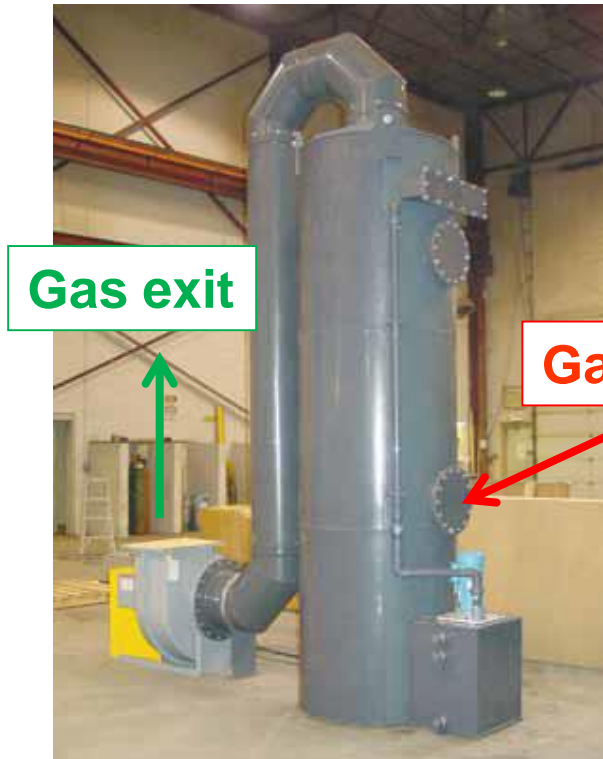

Single wet scrubbers



Two wet scrubbers in series

Wet Scrubbers short review

MUCH CHEMISTRY...

- **ABSORPTION** → EQUILIBRIUM → THERMODYNAMICS, ONLY
- **WET-SCRUBBERS** → NOT AT EQUILIBRIUM → CHEM. KINETICS + GAS TRANSFER (FICK'S LAWS) + "APPROACHING" THERMODYNAMICS (necessary condition! MAX POSSIBLE ABSORPTION)

WS:

- **IN CASE OF ACIDS SCRUBBING**, OFTEN pH SHOULD $>$ THAN REQUIRED BY THERMOD., TO INCREASE THE VELOCITY (CHEM. KIN.) $v = k [A] [B]$, or more complex; $B = OH^-$ (in case of acids scrubbing)

But....the higher the pH the lower the selectivity!

- **SCRUBBING OF ALKALINE GASES** → JUST A FEW (NH_3 , AMINES)
- **RESIDENCE TIME: THE HIGHER, THE BETTER THE WS EFFICIENCY...**

But....the higher the τ the lower the selectivity!

- **WS Energy – conventional classification: LE (spray), ME (packed), HE (venturi)**

But ... Flue-gas desulfurization FGD (High conc. SO_2 removal) → use 3-4 banks of sprays (slurry with 15-20% of solid $CaCO_3 + CaSO_3/SO_4$).

- **WS remove the WG dust:**

But... (common) PACKED WS only for low dust concentration

The primary target of WS is GAS REMOVAL!

DESIGN CONFIGURATION FOR PACKED BED TOWER: MASS TRANSFER THEORY

Design consideration

□ Major components of process design

a) **liquid flow rate L** → mass balance + gas/liquid equilibrium

a) **tower cross section S** → fluid dynamic considerations (pressure drops, gas/liquid contact). The diameter of a packed tower is determined by selecting a cross-sectional area that will provide gas and liquid mass velocities sufficient for good interfacial contact.

b) **tower height Z_T** → mass transfer kinetics

□ General base approach well established for packed and plate tower physical absorption (chemical engineering operations)

□ Empirical approaches available from absorber manufacturers



See
reference
book...
(not topic
for the
exam)

Liquid flow rate L - Detailed Approach

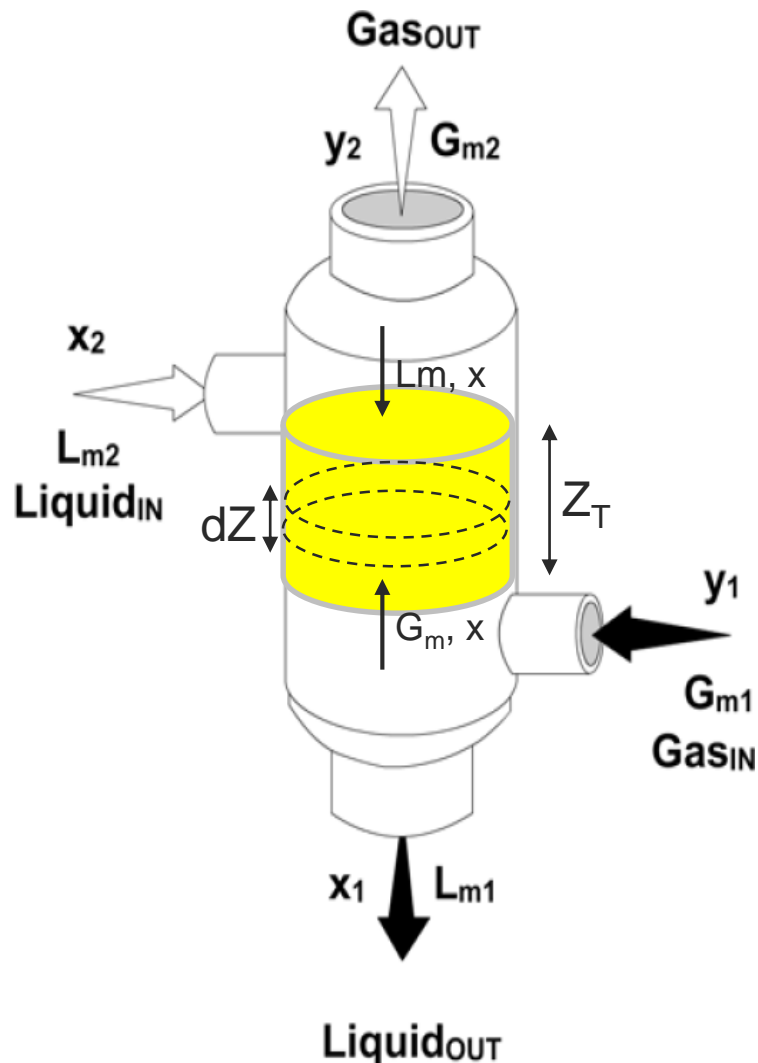

G_m =molar flow rate of the gas (mole/h)
 L_m =molar flow rate of the liquid (mole/h)
 N_A = molar flow rate of A (mole A/h)
 y = mole fraction of A in the gas
 x = mole fraction of A in the liquid

ASSUMPTION

- Steady state condition
- Absorption of a component A (SO_2 , Ammonia) from a non absorbing gas B (air) by a nonvolatile liquid (water) in the tower

Liquid flow rate L - Detailed Approach

The overall and component A balances over the differential section dZ can be written (without regard to sign) as:

$$dL_m = dG_m \quad d(L_m * x) = d(G_m * y) = dN_A$$

Since only component A is transferred between phases (and assuming the liquid is nonvolatile)

$$d(L_m * x) = dL_m = dN_A \quad d(G_m * y) = dG_m = dN_A$$

Writing a component balance from the bottom of the tower, to any point in the tower, we obtain

$$G_{m1} * y_1 - G_m * y = L_{m1} * x_1 - L_m * x \quad \Rightarrow \quad L_m * x + G_{m1} * y_1 = L_{m1} * x_1 + G_m * y$$

Letting L'_m and G'_m equal the molar flow rates of solute-free liquid and solute-free vapor

$$L_m = \frac{L'_m}{1 - x} \quad G_m = \frac{G'_m}{1 - y}$$

Liquid flow rate L - Detailed Approach

$$\frac{L'_m}{1-x} * x + \frac{G'_m}{1-y_1} * y_1 = \frac{L'_m}{1-x_1} * x_1 + \frac{G'_m}{1-y} * y$$

$$G'_m * \left(\frac{y_1}{1-y_1} - \frac{y}{1-y} \right) = L'_m * \left(\frac{x_1}{1-x_1} - \frac{x}{1-x} \right)$$

$$\frac{y}{1-y} = \frac{L'_m}{G'_m} * \left(\frac{x}{1-x} \right) + \left(\frac{y_1}{1-y_1} - \frac{L'_m}{G'_m} * \frac{x_1}{1-x_1} \right)$$

Writing a component balance from the top of the tower, to any point in the tower, we could obtain:

$$\frac{y}{1-y} = \frac{L'_m}{G'_m} * \left(\frac{x}{1-x} \right) + \left(\frac{y_2}{1-y_2} - \frac{L'_m}{G'_m} * \frac{x_2}{1-x_2} \right)$$

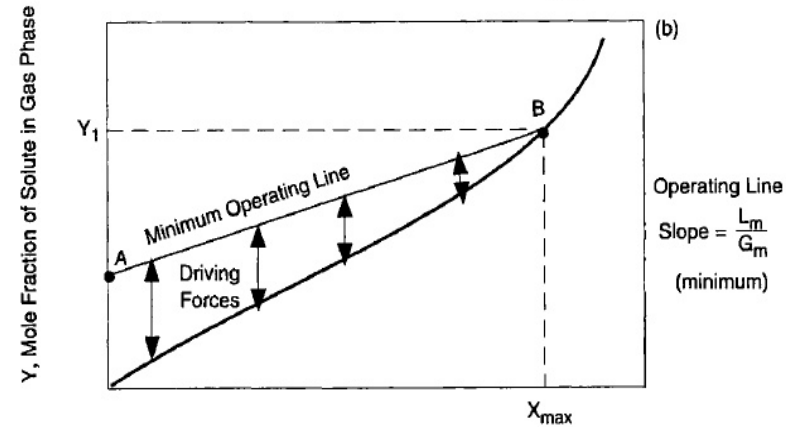
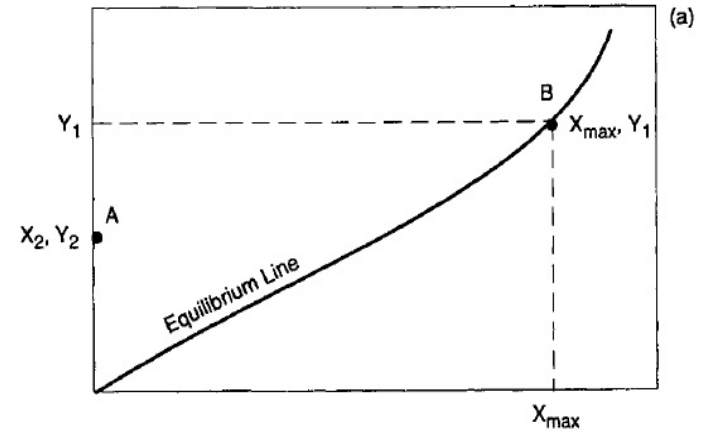

$$X^*_1 = X_{\max}$$

Liquid flow rate L - Detailed Approach

$$\frac{y}{1-y} = \frac{L'_m}{G'_m} * \left(\frac{x}{1-x} \right) + \left(\frac{y_1}{1-y_1} - \frac{L'_m}{G'_m} * \frac{x_1}{1-x_1} \right)$$

The **operating** lines are not straight, the minimum slope operating lines is defined as the straight line connecting points (x_2, y_2) and (x^*_1, y_1) and has slope (L'_m_{min}/G'_m)



Given G'_m we want to minimize L'_m

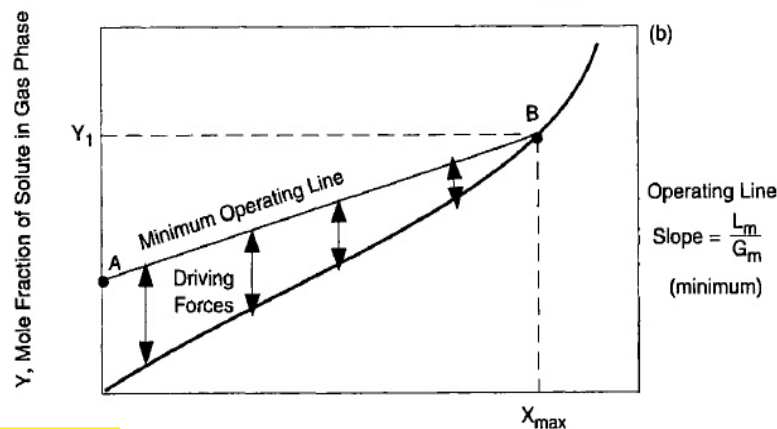
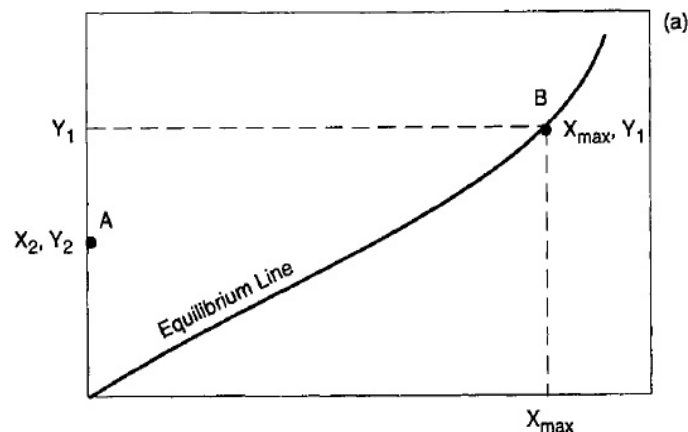

$$G'_m * \left(\frac{y_1}{1-y_1} - \frac{y_2}{1-y_2} \right) = L'_{m,min} * \left(\frac{x^*_1}{1-x^*_1} - \frac{x_2}{1-x_2} \right)$$

$$X^*_1 = X_{max}$$

What happen if the system is diluted? $G'_m=?$ $L'_m=?$ $1-y_1=?$ $1-x^*_1=?$ $1-x_2=?$

Liquid flow rate L - Detailed Approach

○ general assumption → **diluted** streams

- $G_1 = G_2 = \text{constant} = G$ (moles/time)
- $L_1 = L_2 = \text{constant} = L$ (moles/time)
- equilibrium relationship: straight line → $y^* = H \cdot x$

Mass balance
 $G(y_1 - y_2) = L(x_1 - x_2)$

- ❑ straight line with slope L/G on x, y coordinates
- ❑ operating line: operating conditions (gas and liquid composition) along tower height for any L/G ratio
- ❑ unknown design variables: L, x_1 (spent liquid concentration)
- ❑ simultaneous solution of mass balance with equilibrium relationship
- ❑ minimum liquid flow rate **L_{min}**
 - spent liquid in equilibrium with inlet gas:
 - null driving force, infinite time required for gas/liquid transfer, infinite tall column

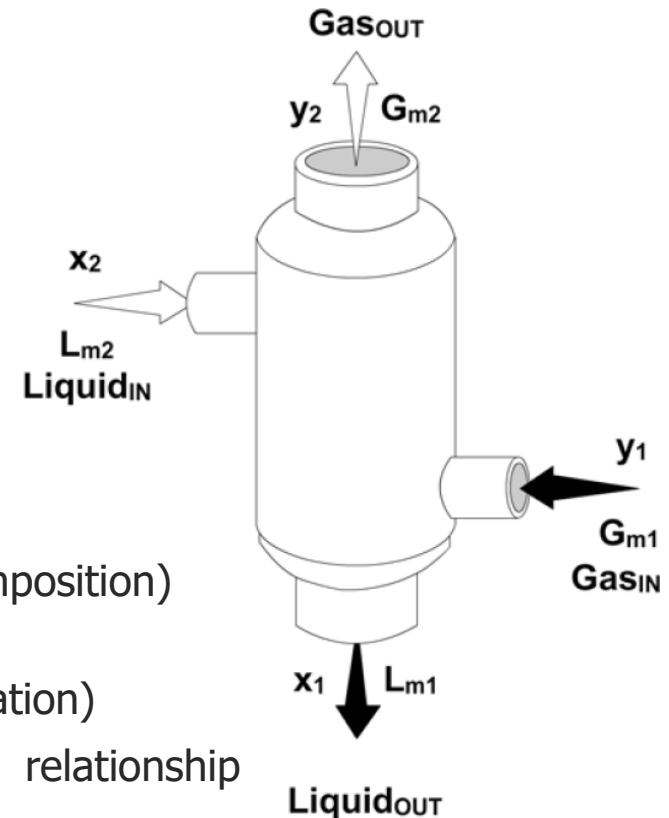

Liquid flow rate L – design consideration

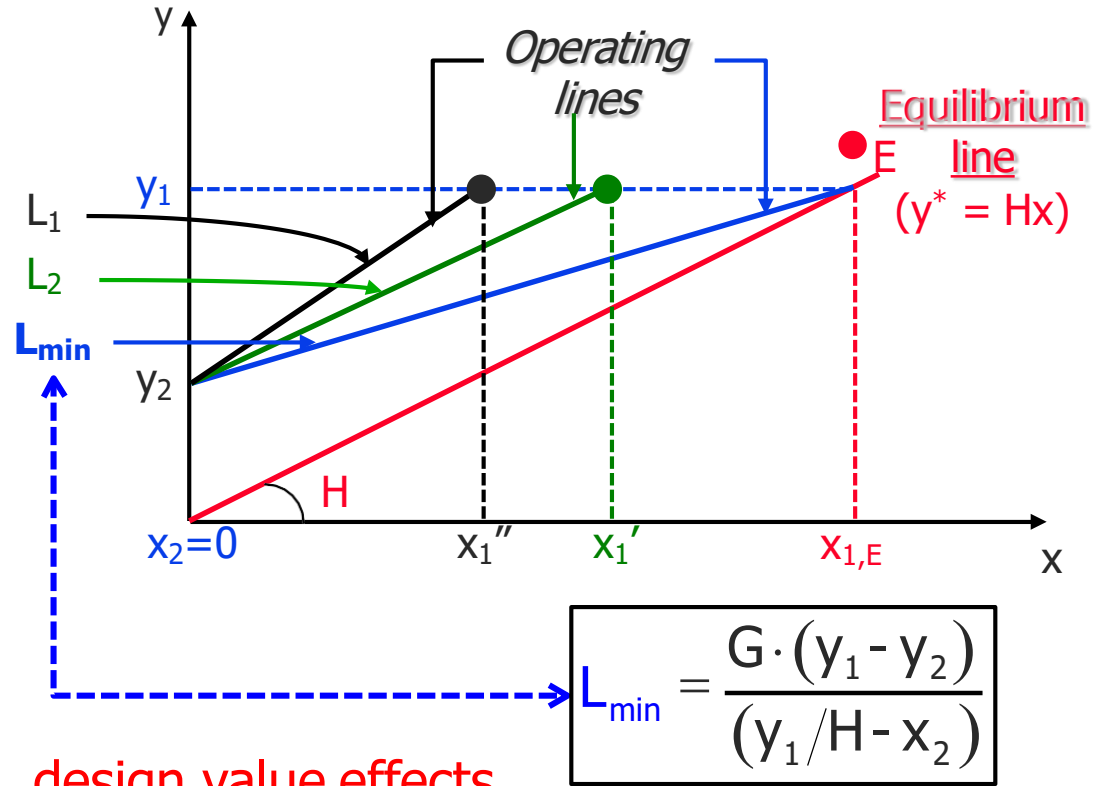
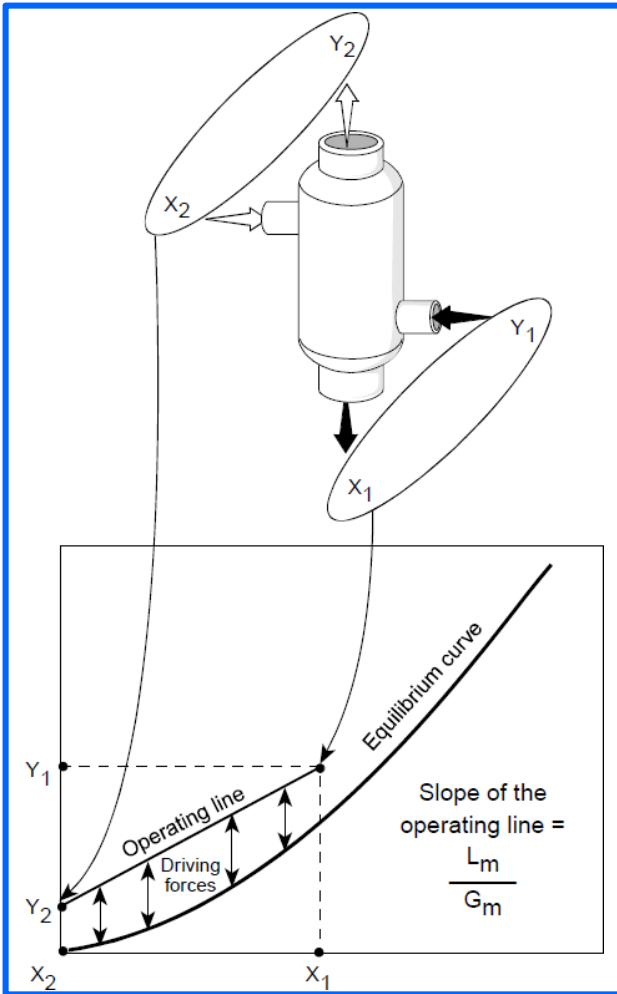

L design value effects

L increase over L_{min}

- low column height (lower capital cost)
- high pumping requirements (higher operating cost)
- diluted spent liquid (lower operating cost)

➤ minimum total costs → generally **$L = 1.5 L_{min}$ (range between 1.25 – 2.5)**

Liquid flow rate L – design consideration

Countercurrent designs provide the highest theoretical removal efficiency because gas with the lowest pollutant concentration (y_2) contacts liquid with the lowest pollutant concentration (x_2). This serves to **maximize** the average driving force for absorption throughout the column.

In the co-current designs, instead, the gas with the lowest pollutant concentration (x_2) doesn't contact liquid with the lowest pollutant concentration (x_2).

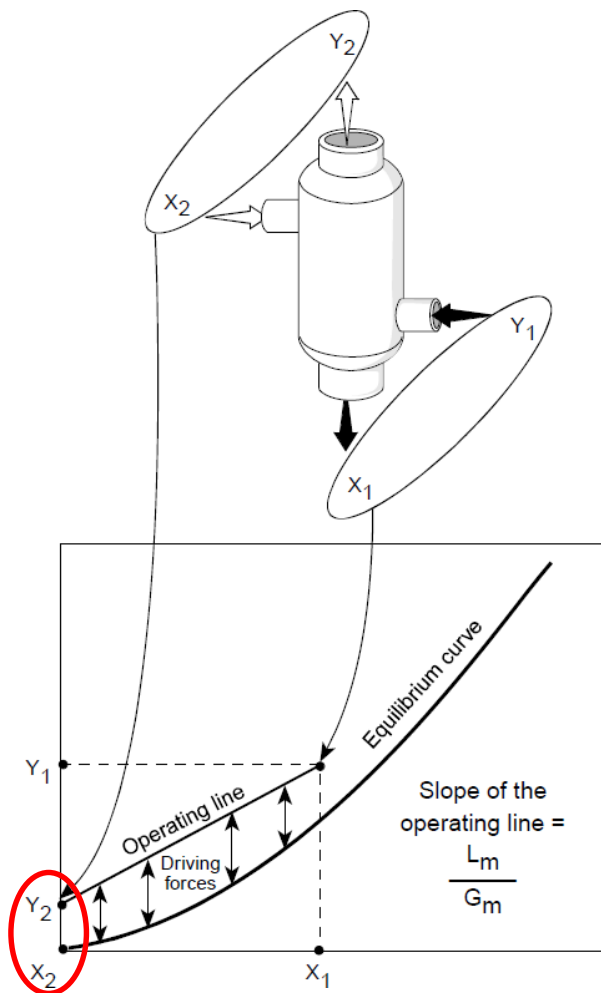

Tower cross section S

- cross sectional area **S** for **optimal gas/liquid contact**
 - optimal gas velocity G' : mass flux per unit cross section [mass/(time·area)]
 - limit condition: **flooding**
 - **G' beyond value where gas upward flow retains** liquid inside the column, due to excess drag (pressure drop): **liquid retention and forced out**
 - low G' (wider sections)
 - poor gas/liquid contact, slower mass transfer kinetics, higher tower height, **high capital cost**
 - lower pressure drops, **lower operating costs**
 - high G' (smaller sections)
 - good gas/liquid contact, fast mass transfer kinetics, smaller tower height, **lower capital cost**
 - higher pressure drops, **higher operating costs**
- generalized correlation charts and/or relationships for G'_{flooding} evaluation (L/G, gas and liquid properties, packing configuration)
- **economic trade-off** between capital and operating costs
 - $G'_{\text{design value}} = 40-70\% G'_{\text{flooding}}$

Tower cross section S

F_p = packing factor from Table 13.4, ft^{-1} (see page 434)

ρ_x = liquid density, lb_m/ft^3

ρ_y = gas density, lb_m/ft^3

μ_x = liquid viscosity, cp

g_c = proportionality constant, $32.17 \text{ ft}\cdot\text{lb}_m/\text{s}^2\cdot\text{lb}_f$

G_x = liquid mass flux, $\text{lb}_m/\text{s}\cdot\text{ft}^2$

G_y = gas mass flux, $\text{lb}_m/\text{s}\cdot\text{ft}^2$

Table 13.4 Tower Packing Characteristics

Type	Material	Nominal Size, in.	Bulk Density,† lb_m/ft^3	Total Area,† ft^2/ft^3	Porosity ϵ	Packing Factors‡	
						F_p	f_p
Berl saddles	Ceramic	½	54	142	0.62	240	\$1.58
		1	45	76	0.68	110	\$1.36
		1½	40	46	0.71	65	\$1.07
Intalox saddles	Ceramic	½	46	190	0.71	200	2.27
		1	42	78	0.73	92	1.54
		1½	39	59	0.76	52	1.18
		2	38	36	0.76	40	1.0
Raschig rings	Ceramic	3	36	28	0.79	22	0.64
		½	55	112	0.64	580	\$1.52
		1	42	58	0.74	155	\$1.36
		1½	43	37	0.73	95	1.0
Pall rings	Steel	2	41	28	0.74	65	\$0.92
		1	30	63	0.94	48	1.54
		1½	24	39	0.95	28	1.36
		2	22	31	0.96	20	1.09
		Polypropylene	1	5.5	63	0.90	52
		1½	4.8	39	0.91	40	1.18

† Bulk density and total area are given per unit volume of column.

‡ Factor F_p is a pressure-drop factor and f_p a relative mass-transfer coefficient.

§ Based on $\text{NH}_3\text{-H}_2\text{O}$ data; other factors based on $\text{CO}_2\text{-NaOH}$ data.

Adapted from McCabe et al., 1985.

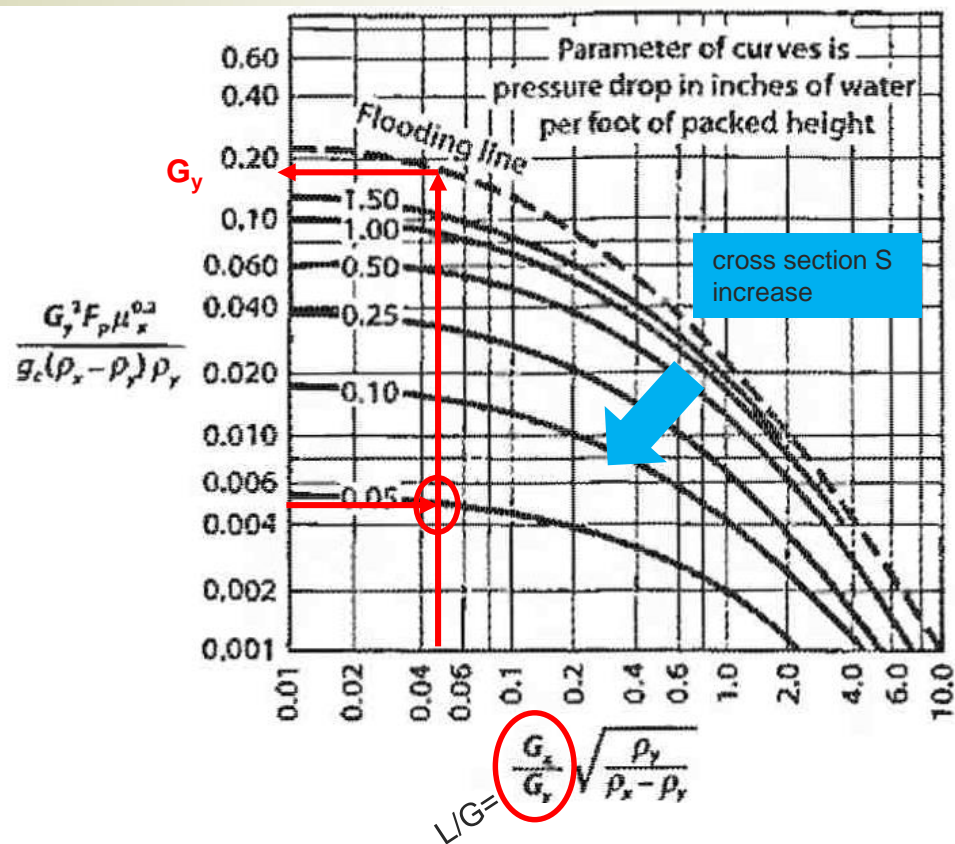

PROCEDURE

1. We calculate the the abscissa value from previously determined values of L and G (converted to mass flow)
2. From the ordinate value we we obtain G_y at flooding
3. The tower diameter (S) is than based on $G_y/2$
4. We use this new value of G_y to calculate a new ordinate value, which is then used to find the pressure drop per foot of packing.

Tower height Z_T – mass transfer kinetics

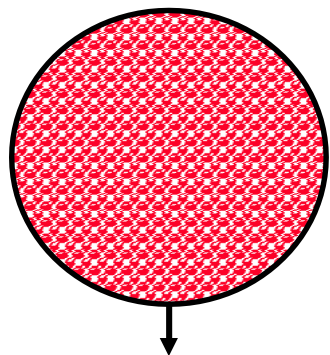
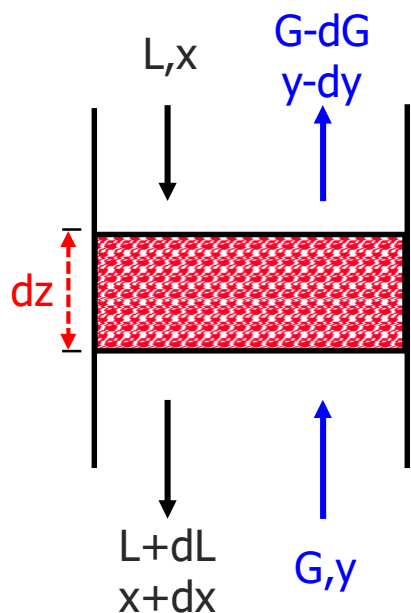

Cross section S

Mass balance along dz
 Mass loss from gas = mass transferred to liquid
 Mass loss from gas = $d(Gy)$
 Mass transferred to liquid = $N = k_y \cdot (a)(Sdz) \cdot (y-y^*)$
 with a = specific surface for gas/liquid (surface/volume)

$$d(Gy) = k_y(y-y^*)aSdz$$

$$Z_T = \int_0^z dz = \int_{y_2}^{y_1} \frac{G}{k_y \cdot a \cdot S} \cdot \frac{dy}{y-y^*} =$$

$$= \left(\frac{G}{k_y \cdot a \cdot S} \right) \left(\int_{y_2}^{y_1} \frac{dy}{y-y^*} \right)$$

Height of transfer unit

Number of transfer units

$$H = N_{OG} H_{OG}$$

Tower height Z_T – mass transfer kinetics

$$H = N_{OG} H_{OG}$$

N_{OG} → index of overall transfer difficulty:
required removal

$$N_{OG} = \int_{y_2}^{y_1} \frac{dy}{y - y^*} = \frac{\text{Required variation in gas concentration}}{\text{Driving force available for transfer}}$$



transfer unit = packed bed height where
variation in gas concentration equals driving
force available for mass transfer

H_{OG} → index of overall transfer efficiency:
dependence with packing type (turbulence,
gas/liquid surface) and driving force

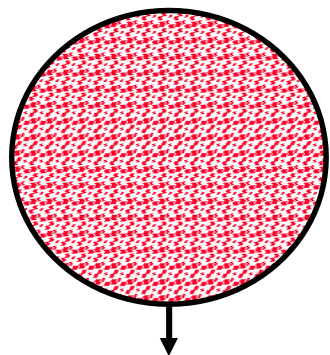
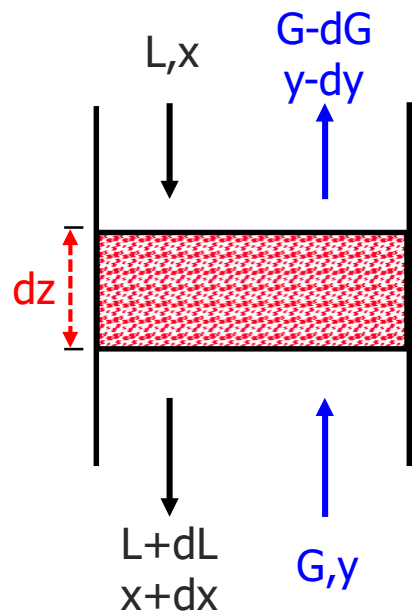

Cross section S

Tower height Z_T – N_{OG} evaluation

$$N_{OG} = \int_{y_2}^{y_1} \frac{dy}{y - y^*}$$

Henry's law

$$y^* = Hx$$

Operating line

$$y = (L/G)(x - x_1) + y_1$$

Analytical integration

$$N_{OG} = \frac{\ln \left[\left(\frac{y_1 - Hx_2}{y_2 - Hx_2} \right) * \left(1 - \frac{1}{A} \right) + \frac{1}{A} \right]}{1 - \frac{1}{A}}$$

A = absorption factor = $(L/G)/H$

= ratio between slope of operating and equilibrium lines: **index of average overall driving force available**

Tower height Z_T – N_{OG} evaluation

- at constant design concentrations (y_{in}, y_{out}, x_{in}), **smaller** N_{OG} (**shorter column height**) for **higher** L/G and/or **higher solubility** (lower H)
- at constant operating parameters (L, G, H, x_{in}), **higher** N_{OG} (**higher column height**) for **higher design removal efficiencies** required (**lower ordinate**)
- for chemical absorption, H may be approximated with 0: thus, $A = \infty$ and $N_{OG} = \ln (y_{in}/y_{out}) = \ln (1/E_T)$

$$N_{OG} = \frac{\ln \left[\left(\frac{y_1 - Hx_2}{y_2 - Hx_2} \right) * \left(1 - \frac{1}{A} \right) + \frac{1}{A} \right]}{1 - \frac{1}{A}}$$

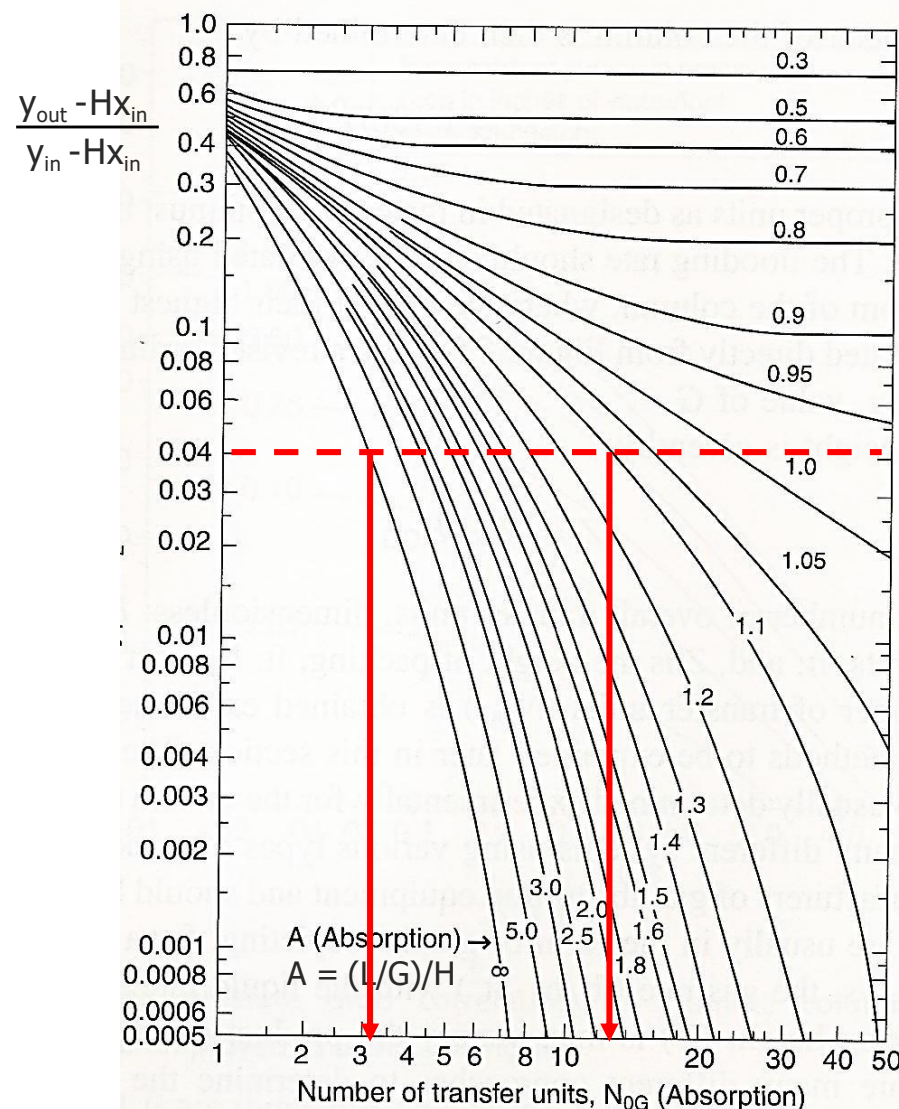

APPLICATIONS

Industrial applicability

Pollutant	Absorption liquid
Halogen gases (HCl, HF, HBr)	Water, sodium hydroxide solutions
SO ₂	Alkaline solutions with lime, calcium carbonate, sodium hydroxide, magnesium oxide, sulphites; seawater
H ₂ S	Alkaline solutions with sodium hydroxide, ammonia, sodium or ammonium carbonate, amines
Organic acids, phenols	Sodium hydroxide solutions
Chlorine	Alkaline solutions with sodium hydroxide, sodium sulphite or thiosulphite
Mercaptans	Sodium hypochlorite solutions
Ammonia	Water, acid solutions (sulphuric, nitric)
Formaldehyde	Ammonia solutions
NO _x	Water, solutions with magnesium oxide, nitrate or carbonate, solutions with ammonium sulphite or bisulphite, acid urea solutions

General operating parameters

Parameter	Typical range	
	Packed bed column	Plate column
Specific flue gas flow rate [(m ³ /h)/m ²]	2000 - 5000	1000 - 5000
Specific liquid flow rate [(m ³ /h)/m ²]	5 - 15	5 - 15
Pressure drop (kPa/m)	0.8 - 1.4	0.5 - 1 (per plate)
Column diameter (m)	0.5 - 5	0.5 - 8
Packing material dimensions (cm)	0.5 - 10	not app.
Packing specific surface (m ² /m ³)	20 - 300	not app.
Plate vertical spacing (cm)	not app.	30 - 90
Plate gas dispersion device diameter (cm)	not app.	Sieve 4 - 20 Bubble 75 - 150 Valve 40 - 50

General application characteristics

○ Advantages

- Very high efficiencies ($> 99\%$) for inorganic pollutants
 - typical adoption in combustion flue gas removal of acid compounds
- Low pressure drops, with the exception of systems for simultaneous removal of high particle loadings (venturi)

○ Disadvantages

- spent liquid treatment and disposal
 - high recycle rates: lower liquid consumption, lower efficiencies, more concentrated spent liquid
 - low recycle rates: high liquid consumption, high efficiencies, diluted spent liquid (reduction in treatment requirements)
- liquid consumption from evaporative cooling
- visible and cool plumes
- potential corrosion and/or scaling problems
- control of parameters influencing chemical absorption (T, pH, redox, ...)